

BLDPN30001 Series 30A Brushless DC Controller

User's Guide



ANAHEIM AUTOMATION

910 East Orangefair Lane, Anaheim, CA 92801
e-mail: info@anaheimautomation.com

(714) 992-6990 fax: (714) 992-0471
website: www.anaheimautomation.com

BLDPN30001 Driver Features

- Maximum Current Limit Setting from 10.0-30.0 Amps (peak)
- Internal or External Potentiometer Speed Control
- 0V to 5V External Voltage Speed Control
- 2-Quadrant Operation
- Hall Sensor Feedback
- Constant Velocity Mode
- Short Circuit Protection
- Requires 90 - 265VAC input power
- Speed Out
- Fault Out
- Run/Stop, Freewheel and Direction
- Selectable Ramp Up
- TTL-CMOS Compatible Inputs
- Compact Size (7.5" x 6.9" x 5.2")
- Works great with 24VDC-36VDC brushless motors
- 48VDC Bus
- Detachable, Screw type Terminal Blocks

General Description

The BLDPN30001 driver is designed to drive DC Brushless Motors at currents of up to 30A (peak) and 50V. Using hall sensor feedback, a constant velocity mode can be selected. The driver is protected against over current (cycle-by-cycle or latched), hall sensor error and under voltage. When an error occurs, a fault light and a fault output are turned on to notify the user. Include on the driver is an internal potentiometer to control the maximum phase current allowed into the motor and an internal potentiometer to control the speed of the motor. An external voltage (0-5VDC) can be used to control the speed as well. The direction of the motor can be preset by the direction control input. Other inputs to the drive include a run/stop and a motor freewheel input. When using the run/stop input, there are three ramp up profiles from standstill to select from. The run/stop input overrides all other inputs into the driver.

Fault Protection

Over current protection can be provided by means of a cover current latch function by setting the 'FLT LATCH' dip switch on. If a motor current level exceeding the current limit set by the internal or external current limit potentiometer is produced, an over current latch is activated, shutting off the output. When a fault is detected, the driver turns off the motor current, the red FAULT LED alerts the user a fault occurred and the Fault Output (TB3 - Pin 5) goes low. The Fault Output is disabled, logic '1' output, when the 'FLT LATCH' dip switch is in the off position and disabled. This Fault protection alerts the user of the following conditions.

1. Invalid Sensor Input Code
2. Over Current. The driver is equipped with cycle-by-cycle current limiting or over current latch.
3. Undervoltage Lockout activation at 9.1VDC for the input voltage and 4.5VDC for Hall Sensor voltage.

Power Supply

No power supply is needed as an internal transformer is used. The supplied line cord is all that is needed to power up the unit. The voltage range of the unit is 90VAC to 265VAC.

Specifications

Control Inputs: (TB1, Pins 1-3)

TTL-CMOS Compatible

Logic "0" = 0-0.8VDC

Logic "1" = OPEN

All three inputs (run/stop, freewheel, and direction) are pulled up through 20k Ohm resistors.

Direction Control: (TB3, Pin 2)

Logic "1" (open) - Clockwise

Logic "0" - Counterclockwise

Freewheel: (TB3, Pin 3)

Logic "1" (open) - Motor is Enabled

Logic "0" - Motor is de-energized and will coast

Run/Stop: (TB3, Pin 4)

Logic "1" (open) - Motor will not run and if running will come to a hard stop

Logic "0" - Motor will run and will accelerate according to ramp dip switch setting

Vcontrol: (TB1, Pin 4)

To control the speed of the motor with an external DC voltage, INT/EXT SPD switch (SW1-POS1) must be switched to the ON position.

0VDC (min) - 5VDC (max)

Control Outputs: (TB3, Pin 1 and 5)

TTL-CMOS Compatible

These outputs are able to sink 50mA

Speed Output: (TB3, Pin 1)

A 5V signal pulse out is available at a rate of 4 pulses for 1 revolution of an 8-pole motor, 3 pulses for 1 revolution of a 6-pole motor, and 2 pulses for 1 revolution of a 4-pole motor.

8-pole motor RPM = 15 * PG OUT (in Hz)

6-pole motor RPM = 20 * PG OUT (in Hz)

4-pole motor RPM = 30 * PG OUT (in Hz)

Fault Output: (TB3, Pin 5)

Logic "1" (5V out) - Status good, normal operation.

Logic "0" - One of the three fault conditions listed in the 'Fault Protection' section has occurred. When a fault is detected, the Fault Output (pin 5) goes low.

Output Current Rating:

Adjustable 10.0 - 30.0 amperes per phase maximum operating peak current

(5.0 - 15.0 amperes per phase maximum operating continuous current)

Power Requirements: (TB2, Pins 4 and 5)

90VAC (min) - 265VAC (max). The unit is protected with two 5mmx20mm 5A fuses. Please review the casing for wiring options.

Operating Temperature:

Heat Sink: 0°-70° C

Hall Sensor Power Output:

6.25V @ 30mA maximum. Typical current draw from hall sensor is 20mA.

All three Hall Sensor inputs are pulled up through 20K ohm resistors.

The external speed control potentiometer must be 10K Ohms.

Open Loop/Closed Loop (Constant Velocity Mode)

The driver can either be set for Open Loop or Closed Loop operation. Open Loop operation is used for applications where the speed of the motor needs to change according to the load. Closed Loop operation is used for applications where speed regulation is needed. Under closed loop operation, the speed is regulated despite changes to the load and the power supply voltage.

To operate Open Loop, the O/C LOOP switch (SW2, pin 1) must be in the 'on' position.

To operate Closed Loop, the O/C LOOP switch (SW2, pin 1) must be in the 'off' position and the CLADJ POT (R3) and CLADJ dip switches (SW2, pin 2-4) must be set to optimize the driver for each application.

If using an Anaheim Automation DC Brushless motor, the tables shown on the next page are the Close Loop potentiometer and dip switch settings for each motor. The regulated speed of the motor is then controlled by adjusting the internal or external speed pot. The motor speed can be monitored by measuring the pulse rate of PG OUT (TB3 - pin 1).

If using a non-Anaheim Automation DC Motor.

1. Start with setting the closed loop switches CL1, CL2, and CL3 on the 'on' position.
2. Set CLADJPOT to 0%.
3. Adjust the internal speed pot or external speed pot to 100% The motor at this time should be running at its maximum speed.
4. Increase the closed loop gain by switching CL1, CL2, and CL3 incrementally one stage until the motor speed dips below the maximum speed. Set the switches up one stage to the position before the motor dips below the maximum speed and proceed to step 5.

CL1	CL2	CL3	CL Gain
On	On	On	Min
Off	On	On	
On	Off	On	
Off	Off	On	
On	On	Off	
Off	On	Off	
On	Off	Off	
Off	Off	Off	Max

5. Slowly rotate CLADJPOT toward 100% until the motor speed slightly begins to decrease. At this point, the motor closed loop adjustments are set.

* If a slower top motor speed is desired, set CLADJPOT to 0%. Increase the closed loop gain incrementally by setting CL1, CL2, CL3 with respect to the desired top motor speed and re-tune CLADJPOT, as described in step 4 and step 5.

Anaheim Automation Motor Closed Loop Settings

4-Pole Motors

Motor	CL1	CL2	CL3	CL POT	MAX SPD (RPM)	MIN SPD (RPM)
BLWR110S-15V-8000	On	On	On	80%	8000	500
BLWR111S-24V-10000	On	On	On	50%	10050	825
BLWR112S-24V-3700	On	Off	On	100%	3735	450
BLWR231D-36V-4000	On	Off	On	65%	4010	550
BLWR232D-36V-4000	On	Off	On	65%	4010	550
BLWR233D-36V-4000	On	Off	On	65%	4010	550
BLWR234D-36V-4000	On	Off	On	65%	4010	550
BLWR235D-36V-4000	On	Off	On	65%	4010	550
BLWR232S-24V-1350	Off	Off	Off	0%	1600	200
BLWS231D-36V-4000	On	Off	On	65%	4010	550
BLWS231S-36V-4000	On	Off	On	65%	4010	550
BLWS232D-36V-4000	On	Off	On	65%	4010	550
BLWS232S-36V-4000	On	Off	On	65%	4010	550
BLWS233S-36V-4000	On	Off	On	65%	4010	550
BLWS234D-36V-4000	On	Off	On	65%	4010	550
BLWS234S-36V-4000	On	Off	On	65%	4010	550
BLWS235-36V-4000	On	Off	On	65%	4010	550

8-Pole Motors

Motor	CL1	CL2	CL3	CL POT	MAX SPD (RPM)	MIN SPD (RPM)
BLY171S-17V-8000	On	On	On	0%	7500	500
BLY172S-17V-9500	On	On	On	0%	9000	500
BLY171S-24V-4000	On	On	On	80%	4000	250
BLY172D-24V-4000	On	On	On	80%	4000	250
BLY172S-24V-4000	On	On	On	80%	4000	250
BLY173D-24V-4000	On	On	On	80%	4000	250
BLY174D-24V-4000	On	On	On	80%	4000	250
BLY174S-24V-4000	On	On	On	80%	4000	250
BLY341D-48V-3200	Off	On	On	40%	3200	250
BLY341S-48V-3200	Off	On	On	40%	3200	250
BLY342D-24V-3000	Off	On	On	40%	3000	250
BLY342D-30V-3000	Off	On	On	40%	3000	250
BLY342D-30V-3000	Off	On	On	40%	3000	250
BLY342D-48V-3200	Off	On	On	30%	3200	250
BLY342S-48V-3200	Off	On	On	30%	3200	250
BLY343D-48V-3200	Off	On	On	30%	3200	250
BLY343S-48V-3200	Off	On	On	30%	3200	250
BLY343S-30V-3000	Off	On	On	40%	3000	250
BLY344D-48V-3200	Off	On	On	30%	3200	250
BLY344S-48V-3200	Off	On	On	30%	3200	250
BLZ362S-36V-3500	Off	On	On	10%	3500	330
BLZ362S-160V-3500	Off	On	On	10%	3500	330
BLZ482S-160V-3500	Off	On	On	10%	3500	330
BLZ242S-24V-3500	Off	On	On	10%	3500	330

Commutation Sequence

	Step					
	1	2	3	4	5	6
Phase A	+	Z	-	-	Z	+
Phase B	Z	+	+	Z	-	-
Phase C	-	-	Z	+	+	Z
Hall A	1	1	0	0	0	1
Hall B	0	1	1	1	0	0
Hall C	0	0	0	1	1	1

120° Hall Spacing Sequence Forward

	Step					
	1	2	3	4	5	6
Phase A	-	Z	+	+	Z	-
Phase B	Z	-	-	Z	+	+
Phase C	+	+	Z	-	-	Z
Hall A	1	1	0	0	0	1
Hall B	0	1	1	1	0	0
Hall C	0	0	0	1	1	1

120° Hall Spacing Sequence Reverse

	Step					
	1	2	3	4	5	6
Phase A	+	Z	-	-	Z	+
Phase B	Z	+	+	Z	-	-
Phase C	-	-	Z	+	+	Z
Hall A	1	1	1	0	0	0
Hall B	0	1	1	1	0	0
Hall C	0	0	1	1	1	0

60° Hall Spacing Sequence Forward

	Step					
	1	2	3	4	5	6
Phase A	-	Z	+	+	Z	-
Phase B	Z	-	-	Z	+	+
Phase C	+	+	Z	-	-	Z
Hall A	1	1	1	0	0	0
Hall B	0	1	1	1	0	0
Hall C	0	0	1	1	1	0

60° Hall Spacing Sequence Reverse

+ = Top Transistor ON, Bottom Transistor OFF, Current Flows into this wire

- = Top Transistor OFF, Bottom Transistor ON, Current Flows out of this wire

Z = Top Transistor OFF, Bottom Transistor OFF, No current into or out of this wire (High Impedance)

Motor Connection

Refer to the hookup diagram for typical driver applications. When connecting a motor for the first time, connect the hall sensor wires (5 of them) to the driver. **DO NOT CONNECT THE PHASES YET.** Turn on power and rotate the motor by hand. If the RED FAULT LED comes on, the hall phases are incorrectly wired. If the RED FAULT LED does not come on then the hall wires are connected correctly. Power the unit down and proceed to connect the motor phases. If the motor does not run or runs erratically, power down and check the speed potentiometer and make sure the phases are connected correctly. There are six different ways to connect the phase wires, and normally only two will allow the motor to rotate, but only one is correct. If the direction of the motor is changed and the no-load current of the motor is approximately the same and the motor runs smoothly in both directions then the phase wires are correct.

The wiring of the motor phases should be separated from the hall and input connections to not allow a possible source of interference.

Terminal and Dip Switch Descriptions

Pin #	Description
1	Hall Sensor Power
2	Hall Sensor A
3	Hall Sensor B
4	Hall Sensor C
5	Hall Sensor Ground

TB1: Motor Hall Terminals

Pin #	Description
1	Phase A
2	Phase B
3	Phase C

TB2: Motor Phase Terminals

Pin #	Description
1	PG OUT
2	Direction
3	Freewheel
4	Run/Stop
5	Fault Out
6	VControl
7	GND

TB3: Control Inputs and Outputs

SW #	Description
1	INT/EXT SPEED
2	FLT LATCH
3	RAMP 1
4	RAMP 2
5	60/120

SW1: Dip Switch

SW #	Description
1	O/C LOOP
2	CL1
3	CL2
4	CL3

SW2: Dip Switch

Dip Switch Settings

Function	SW1	SW2	SW3	SW4	SW5
Internal Speed Control (R46)	Off	---	---	---	---
External Speed Control (TB3 - Pin 6)	On	---	---	---	---
Over Current Latching	---	On	---	---	---
Over Current Cycle-by-Cycle	---	Off	---	---	---
Ramp Profile 1 (4 Sec)	---	---	Off	Off	---
Ramp Profile 2 (2 Sec)	---	---	Off	On	---
Ramp Profile 3 (1 Sec)	---	---	On	Off	---
Ramp Profile 4 (500mSec)	---	---	On	On	---
60° Hall Sensor Spacing	---	---	---	---	Off
120° Hall Sensor Spacing	---	---	---	---	On
Standard Product (Ready to Ship)	Off	Off	Off	Off	On

SW1: Speed Adjustment, Over Current, and Ramp settings

Fault Output

The Fault Output is only active when the Fault Latch is enabled, setting the 'FLT LATCH' dip switch on. The TTL level Fault Output indicates an over current or failure in the motor/driver operation. The Fault Output is normally at a TTL logic level 1. If a fault occurs, the Fault Output will go to a TTL logic level 0.

Dip Switch Settings (cont.)

Function	SW1	SW2	SW3	SW4	SW5
Constant Speed Mode (Closed Loop)	Off	---	---	---	---
Voltage Controlled Speed Mode (Open Loop)	On	---	---	---	---
Closed Loop Compensation 1	---	---	---	---	---
Closed Loop Compensation 2	---	---	---	---	---
Closed Loop Compensation 3	---	---	---	---	---
Standard Product (Ready to Ship)	On	Off	Off	Off	Off

SW2: Open Loop and Closed Loop. If Closed Loop selected, Closed Loop compensation switches must be set according to motor speed desired.

Motor Freewheel

The motor freewheel feature allows the de-energizing of the motor phases. A high (open) input at this input causes the motor to run at the given speed, while a low at this input causes the motor to coast to a stop.

Motor Run/Stop

The motor run/stop feature allows the stopping of a motor by shorting out the bottom drives of the three phases. A low at this input allows the motor to run, while a high (open) input does not allow motor operation and if operating causes rapid deceleration.

Motor Direction

The motor direction feature allows the changing of the rotation of the motor. This input should not be changed while motion is in progress. A high (open) input causes the motor to turn in the CW direction, while a low at this input causes the motor to turn in the CCW direction.

Speed Adjust Setting

There are three ways to set the speed on this drive. One is to use the on-board or external potentiometer. To others is to use an external voltage. To use the on-board potentiometer, set INT/EXT SPD switch to the off position (default). To use the external 10K potentiometer or external 0V to 5V voltage speed setting, set INT/EXT SPD switch to the on position. If a voltage is used to control the speed of the motor, the 0V to 5V voltage can be tied on Vcontrol (TB3 - pin 6) with respect to GND (TB3 - pin 7). If an external potentiometer is used to control the speed of the motor, connect the pot wiper to Vcontrol (TB3 - pin 6), the positive end of the potentiometer to Hall Power (TB1 - pin 1) and the negative end to GND (TB3 - pin 7).

The maximum voltage that can be placed on Vcontrol is 15V. A voltage exceeding 15V may cause damage to the driver. If a voltage other than 0V to 5V is needed to control the speed of the motor, contact Anaheim Automation for custom tuning of the Vcontrol input.

Speed Output

The PG OUT terminal (TB3 - pin 1) is used to determine the speed of the motor shaft. A 5V signal pulse out is shown at a rate of 4 pulses for 1 revolution of an 8-pole motor, 3 pulses for 1 revolution of a 6-pole motor, and 2 pulses for 1 revolution of a 4-pole motor.

# Poles	RPM
8	15 * PG OUT (in Hz)
6	20 * PG OUT (in Hz)
4	30 * PG OUT (in Hz)

Heating Considerations

The chassis fan shouldn't be blocked in any form as this will cause the unit to overheat. The fan should be placed at least 2 inches away from any surface when being mounted. Also the ventilation holes should have proper clearance from any surface to ensure proper unit ventilation.

Typical Wiring Diagram

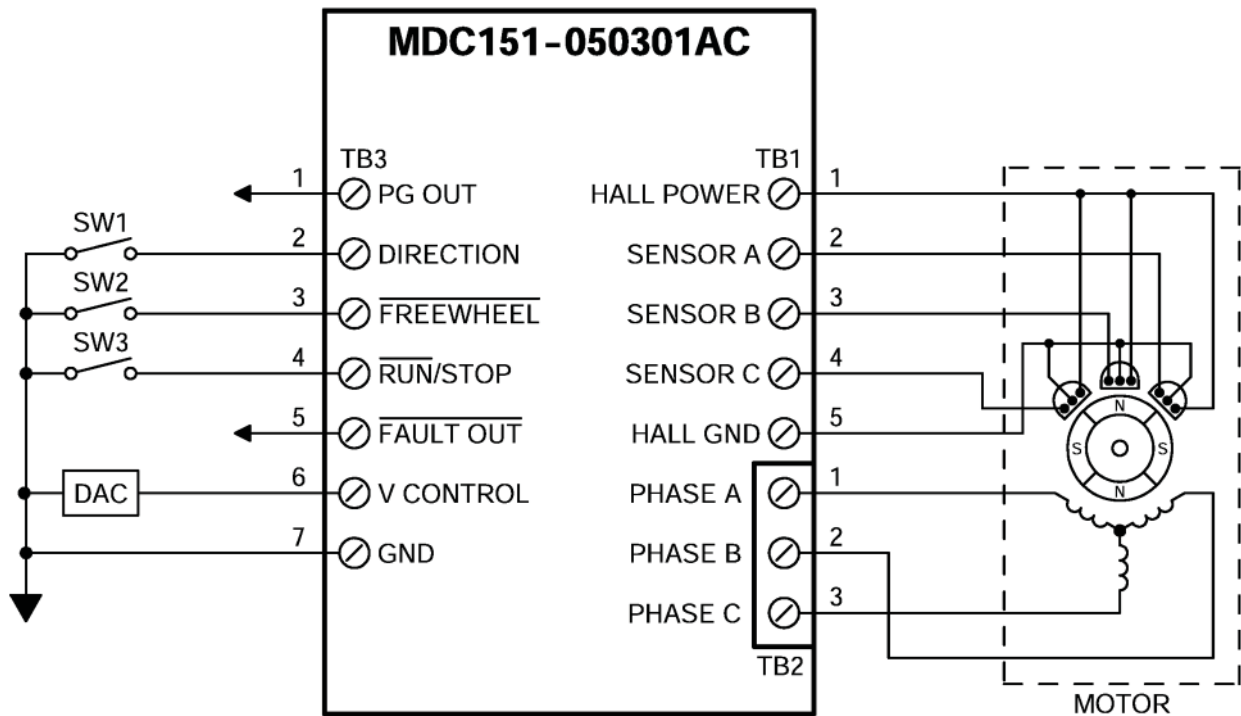

Dimensions

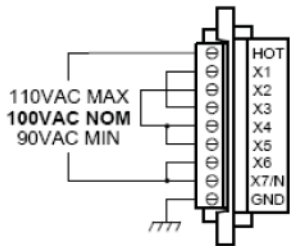
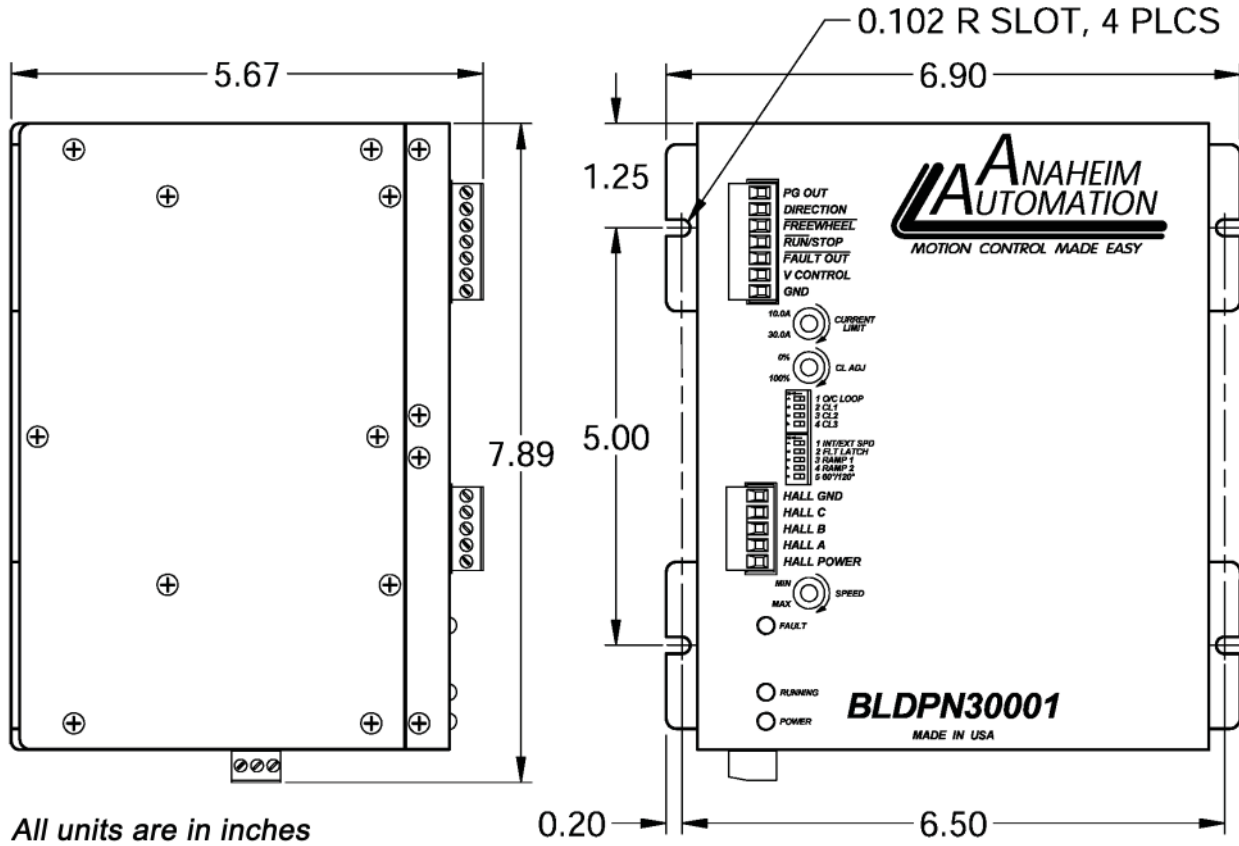

100VAC HOOKUP

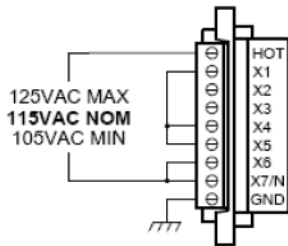

115VAC HOOKUP

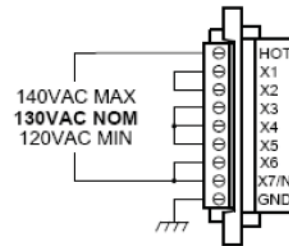

130VAC HOOKUP

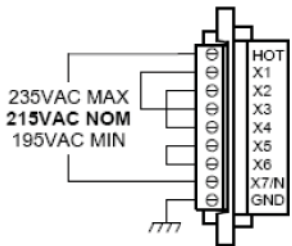

215VAC HOOKUP

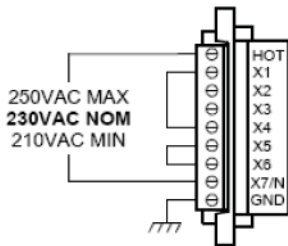

230VAC HOOKUP

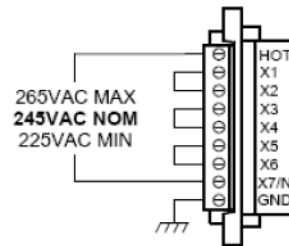

245VAC HOOKUP

COPYRIGHT

Copyright 2012 by Anaheim Automation. All rights reserved. No part of this publication may be reproduced, transmitted, transcribed, stored in a retrieval system, or translated into any language, in any form or by any means, electronic, mechanical, magnetic, optical, chemical, manual, or otherwise, without the prior written permission of Anaheim Automation, 910 E. Orangefair Lane, Anaheim, CA 92801.

DISCLAIMER

Though every effort has been made to supply complete and accurate information in this manual, the contents are subject to change without notice or obligation to inform the buyer. **In no event will Anaheim Automation be liable for direct, indirect, special, incidental, or consequential damages arising out of the use or inability to use the product or documentation.**

Anaheim Automation's general policy does not recommend the use of its' products in life support applications wherein a failure or malfunction of the product may directly threaten life or injury. Per Anaheim Automation's Terms and Conditions, the user of Anaheim Automation products in life support applications assumes all risks of such use and indemnifies Anaheim Automation against all damages.

LIMITED WARRANTY

All Anaheim Automation products are warranted against defects in workmanship, materials and construction, when used under Normal Operating Conditions and when used in accordance with specifications. This warranty shall be in effect for a period of twelve months from the date of purchase or eighteen months from the date of manufacture, whichever comes first. **Warranty provisions may be voided if products are subjected to physical modifications, damage, abuse, or misuse.**

Anaheim Automation will repair or replace at its' option, any product which has been found to be defective and is within the warranty period, provided that the item is shipped freight prepaid, with previous authorization (RMA#) to Anaheim Automation's plant in Anaheim, California.

TECHNICAL SUPPORT

If you should require technical support or if you have problems using any of the equipment covered by this manual, please read the manual completely to see if it will answer the questions you have. If you need assistance beyond what this manual can provide, contact your Local Distributor where you purchased the unit, or contact the factory direct.

ANAHEIM AUTOMATION