

## KNC-PLC-K506 Series



### FEATURES

- Two High Speed Counters
- Two Pulse Train Outputs
- Two Pulse Width Modulation Outputs
- 14 Sinking or Sourcing Inputs
- 10 Outputs
- 1 RS232 Port
- 2 RS485 Ports
- Supports Modbus RTU Protocol
- Communicate with up to 32 devices



### DESCRIPTION

The Kinco K5 series provides many diverse functions and is a cost-effective micro integrated PLC. The K5 CPU provides special I/O functions, CANopen master, multiple RS485 ports, integrated analog inputs/outputs and so on. Equipped with diverse extension modules, the K5 PLCs are equipped to meet requirements of most process control applications. Kinco-K5 seamlessly integrates with the MT4000 HMIs, CD/FD/JD servo drives and inverters to provide users with easy automation solutions. CPU modules are integrated with a certain number of I/O points onboard. If the onboard I/O points are not enough, users can connect up to 6 expansion modules offering up to 136 I/O points, which will meet most automation demands.

### FEATURES

#### High Speed Counters

The K5 PLC provides two high speed counters with 12 different operation modes, supporting single phase frequencies up to 60 KHz and dual-phase (A/B phase) frequencies up to 20 KHz. Each counter has its own inputs for clock, direction, start, reset, and has a 32-bit current and preset value.

#### High-Speed Pulse Outputs

The K5 PLC has two built-in pulse generators that can output frequencies up to 200 KHz, which support PTO (Pulse Train Output) or PWM (Pulse Width Modulation). The KincoBuilder software provides absolute and relative positioning, homing, jog, and quick stop instructions. Kinco-K5 easily controls stepper or servo system, with its pulse and direction outputs.

#### Serial Communication

The K5 PLCs provide 3 serial communication ports; Port 0 is strictly a RS232 port, Ports 1 & 2 are strictly RS485 ports. The K5 PLCs can be networked as slaves with other manufacturers HMIs or other master station devices using the Modbus RTU or ASCII protocols. The K5 PLCs can also work as a master to connect with other PLCs, inverters, instrumentation, actuators, and so on. Each RS485 port supports up to 32 interconnected devices on a single network.

#### Interrupts

The K5 PLC provides edge (I0.0-I0.3), communication, timer, high-speed counter interrupts and so on. Interrupt routines run in real time, can capture rising/falling edges of digital inputs, and are not affected by the PLC cycle.

#### PID

The K5 PLC provides PID control via an easy to use function block. User can call up to 4 PID function blocks in one PLC program. The PID function block accepts analog inputs as a PV value for PID, meanwhile, send the PID output value directly to an analog output.

#### Integrated 24 Vdc Sensor Supply

CPU modules provide a 24 Vdc power supply (Pins: VO+, VO-), with maximum current up to 500 mA. It can supply 24 Vdc for the connected HMI and digital inputs.

Transport and Storage		
Climatic Conditions	Temperature	Temperature -40 °C ~ + 70 °C
	Relative Humidity	10% ~ 95%, Non-Condensing
	Atmospheric Pressure	Correspond to Altitude 0 ~ 3000 m
Mechanical Conditions	Free Drop	Away from 1 m Height Drop to Cement Floor for 5 Times with Transportation Package

Operation		
Climatic Conditions	Temperature	Opening Device with Natural Ventilation, Ambient Temperature: 0 ~ 55 °C
	Relative Humidity	10% ~ 95%, Non-Condensing
	Atmospheric Pressure	Altitude Below 200 m
	Pollution Degree	Applicable to Pollution Degree 2
Mechanical Service Conditions	Vibrations	5<f<8.4 Hz, Random Amplitude: 3.5 mm Displacement, Constant Amplitude: 1.75 mm Displacement 8.4<f<150 Hz, Random Amplitude: 1.0 g Acceleration, Constant Amplitude: 0.5 g Acceleration
	Shock	Half-sine, 15 g peak, 11 ms Duration, Three Shocks in each Direction per Axis.
Electromagnetic Compatibility (EMC)	Electrostatic Discharge	Air: 8 kV, Contact: 4 kV, Performance Criteria B
	Surge	AC Supply: 2 KV CM, 1 KV DM DC Supply: 0.5 KV CM, 0.5 KV DM I/O and Communication Port: 1 KV CM Performance Criteria B
	Fast Transient Bursts	Power Coupling: 2 KV, 5 KHz I/O and Communication Port: 1 KV, 5 KHz Performance Criteria B
	Voltage Dips and Interruptions	AC Supply, @ 50 Hz 0% Voltage for 1 Period, 40% Voltage for 10 Periods, 70% Voltage for 20 Periods. Performance Criteria A
	Radio Frequency Electromagnetic Field	80 ~ 100 MHz, 10 V/m, Modulate by 1 KHz Sine Wave Class C
Protection Class	Dust and Water Proof	IP20

L011157

# KNC-PLC-K506 Series



PLC SPECIFICATIONS

Parameter	KNC-PLC-K506	KNC-PLC-K506EA
Built-in Discrete Inputs / Outputs	14 Inputs / 10 Outputs	14 Inputs / 10 Outputs
Discrete Input Type	Sinking or Sourcing	
Discrete Input Voltage	Rated: 24 Vdc; Maximum: 30 Vdc	
Rated Discrete Input Current	3.5 mA @ 24 Vdc	
Minimum Input Voltage of Logic "1"	Normal Input: 11 Vdc @ 2.0 mA; High-Speed Input: 18 Vdc @ 2.5 mA	
Maximum Input Voltage of Logic "0"	5 Vdc @ 0.7 mA	
Input Delay	Normal Input: 12 µs; High-Speed Input: 8 µs	
• Off-to-On	Normal Input: 40 µs; High-Speed Input: 12 µs	
• On-to-Off		
Built-in Analog Inputs / Outputs	----	4 Inputs / 2 Outputs
Analog Input/Output Resolution	----	12-Bit
Analog Input/Output Conversion	----	~30 Times/Minute
Analog Input Measurement Accuracy	----	0.3% Full Scale
Analog Input Signal	----	0~20 mA, 4~20 mA, 0~10 Vdc, 1~5 Vdc
Analog Input Impedance	---	Current Mode: < 250 Ω, Voltage Mode: >4 MΩ
Analog Output Accuracy	----	0.5% Full Scale
Analog Output Signal	----	0~20 mA, 4~20 mA, 0~10 Vdc, 1~5 Vdc
Analog Output External Load	----	Current Mode: <500 Ω, Voltage Mode: >1 KΩ
Number of Connectable Expansion Modules	6	6
Communication Ports	PORT 0: RS232, PORT 1 & 2: RS485	
	PORT0 Supports Programming Protocol, Modbus RTU Master, and Free Protocol PORT1 & PORT2 Support Modbus RTU Master and Slave, and Free Protocol	
High-Speed Counter	4	
Single-Phase	2, Max 60 KHz	
Dual-Phase	2, Max 20 KHz	
Pulse Output	2, Max 200 KHz	
User Program Memory	Max 4 Ksteps	
User Data Memory	M area 1 KB, V area 4 KB	
Discrete Input Mapping Area	32 Bytes (256*DI)	
Discrete Output Mapping Area	32 Bytes (256*DO)	
Analog Input Mapping Area	64 Bytes (32*AI)	
Analog Output Mapping Area	64 Bytes (32*AO)	
Data Backup Characteristic	FRAM, 448 Bytes	
Data Retention Characteristic	4 KB. Lithium Battery, 3 Years at Normal Temperature	
Timer	256	
	1 ms time base: 4	
	10 ms time base: 16	
	100 ms time base: 236	
Timer Interruption	2 Time base: 0.1 ms	
Counter	256	
Real Time Clock	Yes, with an Error Less than or Equal to 2 Minutes/Month Under a Temperature of 25 °C	
24 Vdc Output Supply	500 mA, Short Circuit Protection	

L011157

Discrete Inputs	
Input Type	Sourcing or Sinking
Input Voltage	Rated 24 Vdc, Allowable Maximum 30 Vdc
Rated Input Current	3.5 mA @ 24 Vdc
Minimum Input Voltage of Logic "1"	Normal Channel: 11 Vdc @ 2.0 mA High-Speed Channel: 18 Vdc @ 2.5 mA
Maximum Input Voltage of Logic "0"	5 Vdc @ 0.7 mA
Input Delay • Off-to-On • On-to-Off	Common Channel 12 $\mu$ s; High-Speed Channel 8 $\mu$ s Common Channel 40 $\mu$ s; High-Speed Channel 12 $\mu$ s
Isolation Between Input and Internal Circuit • Mode • Voltage	Opto-Electrical Isolation 500 Vac / 1 Minute

Discrete Outputs ( Transistor )	
Output Type	Sourcing
Output Voltage	Rated 24 Vdc, Allowable Range: 20.4 - 28.8 Vdc
Output Current per Channel	Maximum 500 mA @ 24 Vdc
Parallel Connection of Output Channels	Yes
Protection Function: • Power Supply Access Polarity Protection • Inductive Load Protection • Short-Circuit Protection • Output Reverse Polarity Protection	Yes Yes Yes Yes, Allows Reverse Polarity at the Output End for No More than 10 Seconds
Isolation Between Output and Internal Circuit • Mode • Voltage	Opto-Electrical Isolation 500 Vac / 1 minute

Discrete Outputs ( Relay )	
Output Type	Relay
Maximum Load Voltage	30 Vdc / 250 Vac
Maximum Allowable Load Current	2 A @ 30 Vdc / 250 Vac
Output off-on delay	Maximum delay of 10 ms
Output on-off delay	Maximum delay of 5 ms
Protection Function: • Power Supply Access Polarity Protection • Inductive Load Protection • Short-Circuit Protection • Output Reverse Polarity Protection	Yes Yes Yes Yes, Allows Reverse Polarity at the Output End for No More than 10 Seconds
Isolation Between Output and Internal Circuit • Mode • Voltage	Opto-Electrical Isolation 500 Vac / 1 minute

L011157

# KNC-PLC-K506 Series



ANALOG I/O SPECIFICATIONS

Analog Inputs	
Resolution	12-bit
Measurement Accuracy	0.3% Full Scale
Signal Form	4~20 mA, 0~20 mA, 0~10 Vdc, 1~5 Vdc. Bearable Maximum Input Voltage is 15 Vdc
Conversion Rate	About 30 times / min
Input Impedance	Current Mode: < 250 Ω Voltage Mode: > 4 MΩ
Anti Common-Mode Voltage	(Signal Voltage + Common-Mode Voltage) ≤ 12 Vdc. Exceed this Range, the Channel Will Go Into a Protection State.
Status Indication	The Red LED of Each Channel Indicates 4~20 mA or 1~5 Vdc Inputs Signal Exceeds Measurement Range.

Analog Outputs	
Resolution	12-bit
Output Signal Accuracy	0.5% Full Scale
Signal Form	4~20 mA, 0~20 mA, 0~10 Vdc, 1~5 Vdc
Conversion Rate	About 30 times / min
External Load	Current Mode: < 500 Ω Voltage Mode: > 4 KΩ
Status Indication	No

PLC DESCRIPTIONS

KNC-PLC-K506-24AT	
Power Supply	85-265 VAC
Built-In Digital Inputs	14 Sinking or Sourcing
Built-In Digital Outputs	10 ( Transistor Type) Sourcing
Number of Connectable Expansion Modules	6
Communication Ports	Port 0: RS232/RS485 Port 1: RS485 Port 2: RS485  Port 0 Supports Programming Protocol, Modbus RTU Master, Free Protocol Port 1/2 Support Modbus RTU Master and Slave, Free Protocol
Real-Time Clock	Yes
Installation Size (mm)	125 x 114 x 70 ( L x W x H )

KNC-PLC-K506-24AR	
Power Supply	85-265 VAC
Built-In Digital Inputs	14 Sinking or Sourcing
Built-In Digital Outputs	10 ( Relay Type)
Number of Connectable Expansion Modules	6
Communication Ports	Port 0: RS232/RS485 Port 1: RS485 Port 2: RS485  Port 0 Supports Programming Protocol, Modbus RTU Master, Free Protocol Port 1/2 Support Modbus RTU Master and Slave, Free Protocol
Real-Time Clock	Yes
Installation Size (mm)	125 x 114 x 70 ( L x W x H )

L011157

# KNC-PLC-K506 Series



PLC DESCRIPTIONS

KNC-PLC-K506-24DT	
Power Supply	22-28 VDC
Built-In Digital Inputs	14 Sinking or Sourcing
Built-In Digital Outputs	10 ( Transistor Type) Sourcing
Number of Connectable Expansion Modules	6
Communication Ports	Port 0: RS232/RS485 Port 1: RS485 Port 2: RS485  Port 0 Supports Programming Protocol, Modbus RTU Master, Free Protocol Port 1/2 Support Modbus RTU Master and Slave, Free Protocol
Real-Time Clock	Yes
Installation Size (mm)	125 x 114 x 70 ( L x W x H )

KNC-PLC-K506-24DR	
Power Supply	22-28 VDC
Built-In Digital Inputs	14 Sinking or Sourcing
Built-In Digital Outputs	10 ( Relay Type)
Number of Connectable Expansion Modules	6
Communication Ports	Port 0: RS232/RS485 Port 1: RS485 Port 2: RS485  Port 0 Supports Programming Protocol, Modbus RTU Master, Free Protocol Port 1/2 Support Modbus RTU Master and Slave, Free Protocol
Real-Time Clock	Yes
Installation Size (mm)	125 x 114 x 70 ( L x W x H )

KNC-PLC-K506EA-30AT	
Power Supply	85-265 VAC
Built-In Digital Inputs	14 Sinking or Sourcing
Built-In Digital Outputs	10 ( Transistor Type) Sourcing
Built-In Analog Inputs	4 ( Current/Voltage ) 4-20 mA, 0-20 mA, 0-10 Vdc, 1-5 Vdc
Built-In Analog Outputs	2 ( Current/Voltage ) 4-20 mA, 0-20 mA, 0-10 Vdc, 1-5 Vdc
Number of Connectable Expansion Modules	6
Communication Ports	Port 0: RS232/RS485 Port 1: RS485 Port 2: RS485  Port 0 Supports Programming Protocol, Modbus RTU Master, Free Protocol Port 1/2 Support Modbus RTU Master and Slave, Free Protocol
Real-Time Clock	Yes
Installation Size (mm)	200 x 114 x 70 ( L x W x H )

L011157

# KNC-PLC-K506 Series



WIRING DIAGRAMS

**KNC-PLC-K506-24AR**

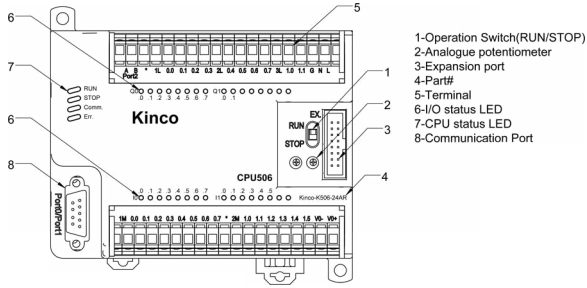

**KNC-PLC-K506-24AT**

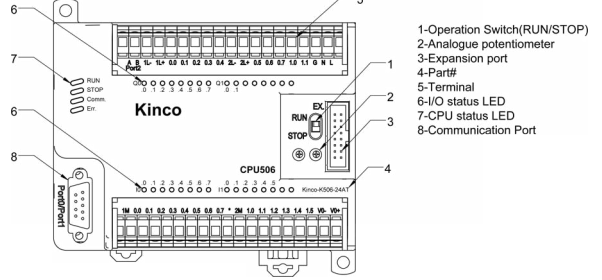

**KNC-PLC-K506-24DR**

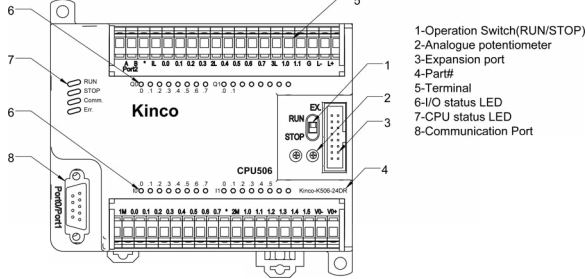

**KNC-PLC-K506-24DT**

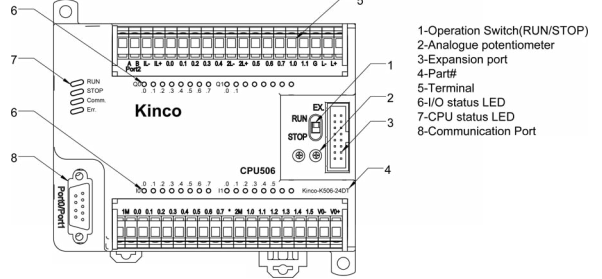

**KNC-PLC-K506EA-30AT**

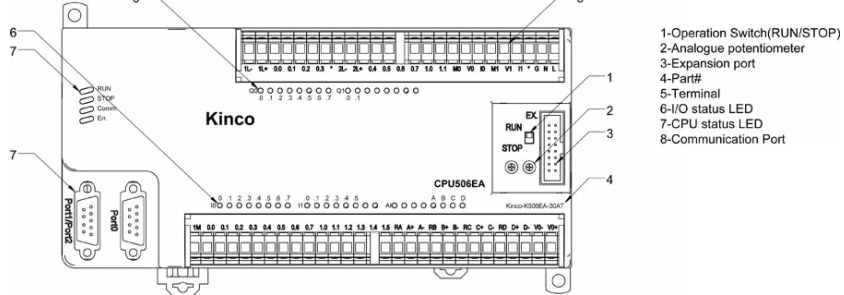

DIMENSIONS

**K506-24**

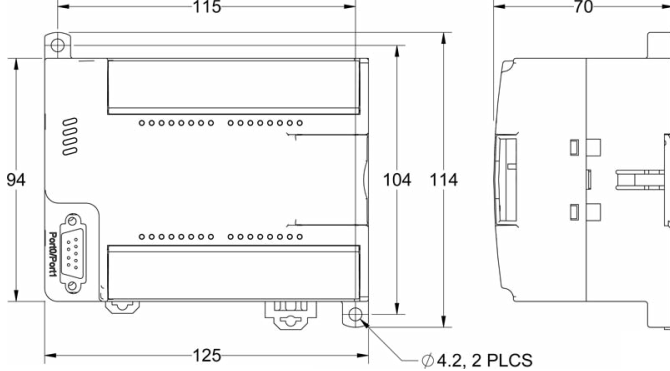

**K506EA-30**

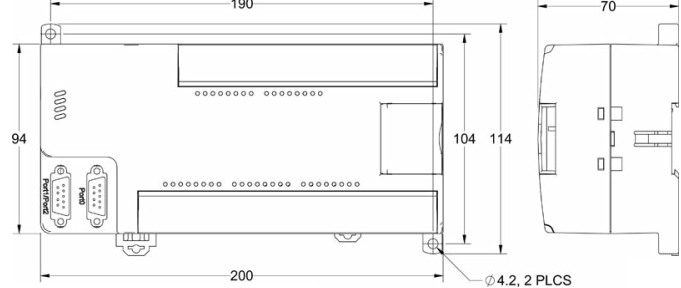

L011157

# KNC-PLC-K506 Series

SERIAL COMMUNICATION PIN DEFINITION

**Port 0**

Port 0 Is a DB9 Female Port, this Port Supports RS-232C Communication Only, the Pin Definitions are as Follows:

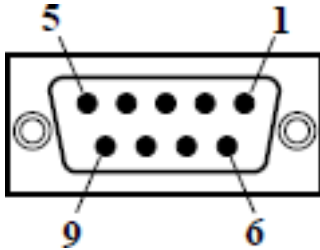

Pin	Function
	RS-232C
1	--
2	Rx
3	Tx
4	--
5	Signal Ground
6	--
7	--
8	--
9	--

**Port 1**

Port 1 And Port 0 Use the Same Physical Port, the DB9 Female Port. This Port Supports RS-485 Communication Only, the Pin Definitions are as Follows:

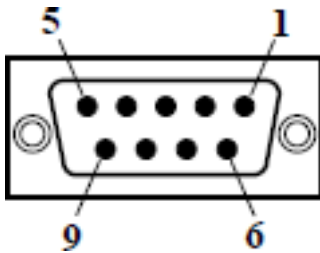

Pin	Function
	RS-485
1	--
2	--
3	--
4	--
5	Signal Ground
6	--
7	Data+(B)
8	Data-(A)
9	--

**Port 2**

Port 2 Is on the Output Terminal Block and Labeled A ( non-inverting ) and B ( inverting ), This Port Supports RS-485 Communication Only, the Pin Definitions are as Follows.



Pin	Signal
A	Data+(A)
B	Data-(B)

**\*\*\*\*NOTE**

The above communication wiring diagrams are for all of the KNC-PLC-K506 units except for the KNC-PLC-K506EA-30AT. The next page shows the KNC-PLC-K506EA-30AT communication wiring diagram.

L011157



**Port 0**

Port 0 is a DB9 Female Port, this Port Supports RS-232C Communication Only, the Pin Definitions are as Follows:

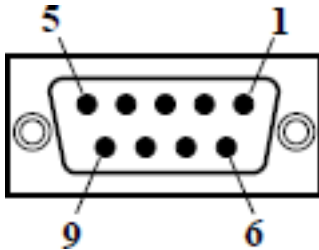

Pin	Function
	RS-232C
1	--
2	Rx
3	Tx
4	--
5	Signal Ground
6	--
7	--
8	--
9	--

**Port 1**

Port 1 And Port 2 Use the Same Physical Port, the DB9 Female Port. This Port Supports RS-485 Communication Only, the Pin Definitions are as Follows:

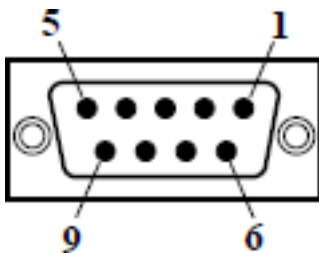

Pin	Function
	RS-485
1	--
2	Data+(B)
3	Data-(A)
4	--
5	Signal Ground
6	--
7	--
8	--
9	--

**Port 2**

Port 2 And Port 1 Use the Same Physical Port, the DB9 Female Port. This Port Supports RS-485 Communication Only, the Pin Definitions are as Follows:

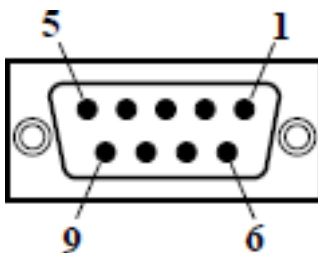

Pin	Function
	RS-485
1	--
2	--
3	--
4	--
5	Signal Ground
6	--
7	Data+(B)
8	Data-(A)
9	--

L011157