

KNC-SRV-SMH40S Servo



FEATURES

- **40mm Frame Size**
- **220VAC**
- **Power Rating up to 100 Watts**
- **Rated Torque up to 45 oz-in**
- **Rated Speed of 3000 RPM**
- **Brake Option Available**
- **2500PPR Incremental Encoder Included**
- **Totally Enclosed, Non-Ventilated**
- **IP65 Protection for Body, IP54 Shaft Sealing**
- **CE Certified**



DESCRIPTION

The KNC-SRV-SMH40S Series Servo Motor offers a solution to servo applications requiring position and speed control. This servo motor series comes standard with a 2,500 Pulses per Revolution (PPR) Incremental Encoder, runs at a rated speed of 3000 RPM, provides peak values up to 300% of the rated torque and current values, and has a rated torque up to 45 oz-in with a 50-100 Watt power rating. This servo motor series enables industrial motion control applications to attain a great combination of position and speed functionality.

SPECIFICATIONS

Model	KNC-SRV-SMH40S-0005-30AAK-4LKH KNC-SRV-SMH40S-0005-30ABK-4LKH	KNC-SRV-SMH40S-0010-30AAK-4LKH KNC-SRV-SMH40S-0010-30ABK-4LKH
Compatible Driver	KNC-SRV-FD412-LA-000	
DC Link Voltage (VDC)	300	300
Rated Power (W)	50	100
Rated Torque (oz-in)	22	45
Rated Speed (RPM)	3000	3000
Max Speed (RPM)	6500	6500
Rated Current (A)	0.7	1.4
Maximum Torque (oz-in)	67	135
Maximum Current (A)	2.1	4.2
Standstill Torque (oz-in)	24	49
Standstill Current (A)	0.77	1.32
Resistance Line-Line (Ω)	16.6	5.53
Inductance Line-Line (mH)	14	6
Electrical Time Constant (ms)	0.84	1.08
Mechanical Time Constant (ms)	1.28	0.86
Reverse Voltage Constant K_e (V/krpm)	16	16
Torque Constant K_t (oz-in/A)	37.527	37.527
Rotor Moment of Inertia J_m (oz-in-s ²)	0.00044 0.00046 (with brake)	0.00084 0.00086 (with brake)
Pole Pair Number	4	4
Maximum Voltage Rising du/dt (KV/ μ s)	8	8
Insulation Class	F	F
Maximum Radical Force F (N)	120	120
Maximum Axial Force F (N)	60	60
Weight (lbs)	1.11 1.77 (with brake)	1.77 2.21 (with brake)

L011229 *Note: Part Numbers with -30ABK are equipped with a brake.

- **40mm Frame Size**
- **60 VDC**
- **Power Rating up to 100 Watts**
- **Rated Torque up to 45 oz-in**
- **Rated Speed of 3000 RPM**
- **2500PPR Incremental Encoder Included**
- **Totally Enclosed, Non-Ventilated**
- **IP65 Protection for Body, IP54 Shaft Sealing**
- **CE Certified**



SPECIFICATIONS

Model	KNC-SRV-SMH40S-0005-30AAK-4DKH	KNC-SRV-SMH40S-0010-30AAK-4DKH
Compatible Driver	KNC-SRV-FD122-CA-000	
DC Link Voltage (VDC)	60	60
Rated Power (W)	50	100
Rated Torque (oz-in)	22	45
Rated Speed (RPM)	3000	3000
Rated Current (A)	1.2	2.5
Maximum Torque (oz-in)	67	135
Maximum Current (A)	3.6	7.5
Standstill Torque (oz-in)	24	49
Standstill Current (A)	1.32	2.75
Resistance Line-Line (Ω)	4.2	2.1
Inductance Line-Line (mH)	3.5	2.5
Electrical Time Constant (ms)	0.84	1.2
Mechanical Time Constant (ms)	1.28	1.22
Reverse Voltage Constant K_e (V/krpm)	16	16
Torque Constant K_t (oz-in/A)	18.7	18.7
Rotor Moment of Inertia J_m (oz-in-s ²)	0.00044	0.00084
Pole Pair Number	4	4
Maximum Voltage Rising du/dt (KV/ μ s)	8	8
Insulation Class	F	F
Maximum Radical Force F (N)	120	120
Maximum Axial Force F (N)	60	60
Weight (lbs)	1.11 1.77 (with brake)	1.77 2.21 (with brake)

L011229

KNC-SRV-SMH40S-0005-30AAK-4LKH, KNC-SRV-SMH40S-0005-30AAK-4DKH, KNC-SRV-SMH40S-0010-30AAK-4LKH, and KNC-SRV-SMH40S-0010-30AAK-4DKH

DIMENSIONS

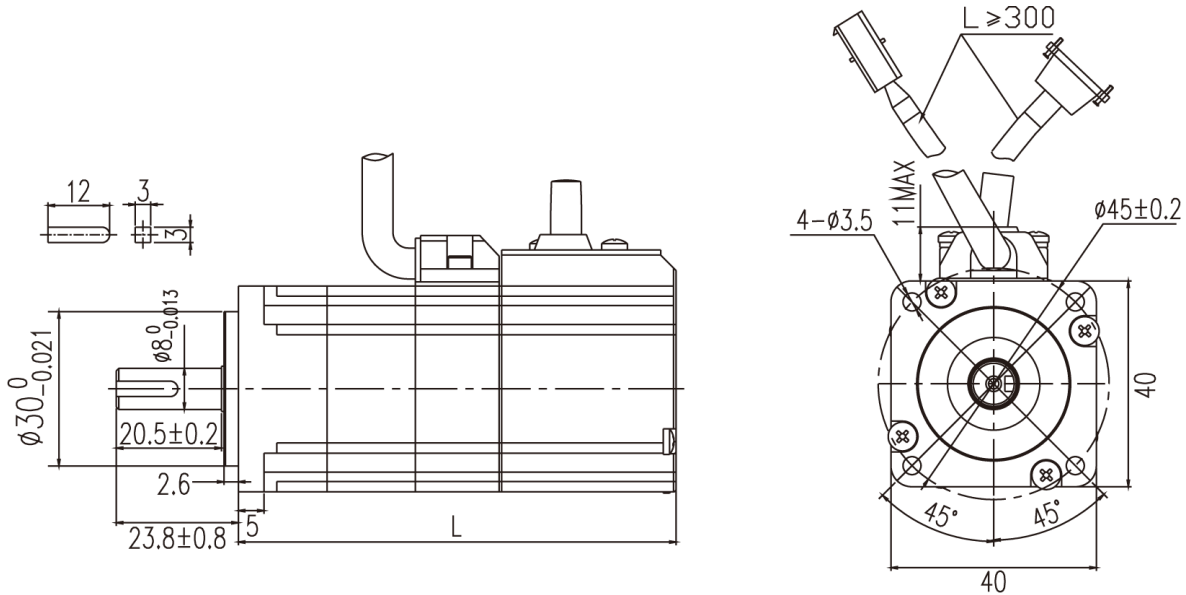

KNC-SRV-SMH40S-0005-30ABK-4DKH and KNC-SRV-SMH40S-0010-30ABK-4DKH

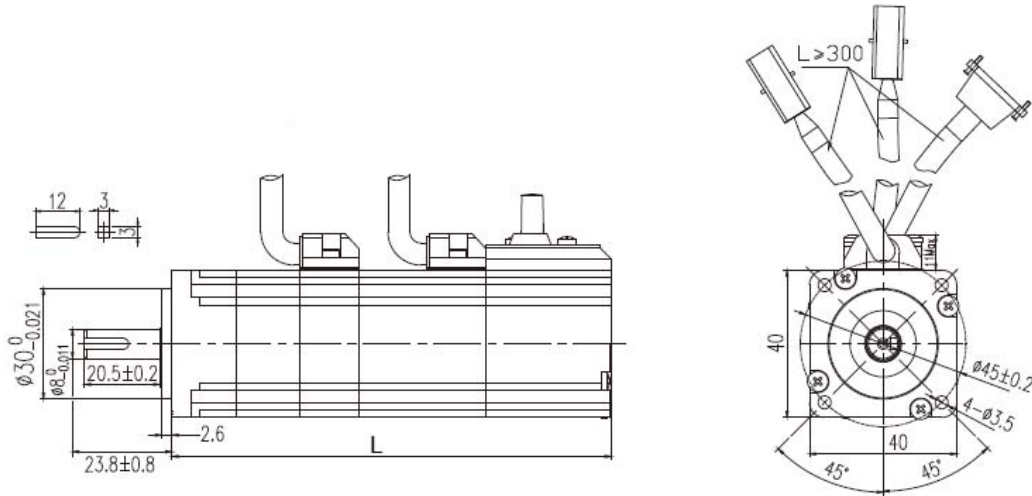

MOTOR LENGTHS

Model	KNC-SRV-SMH40S-0005-30AAK-4LKH KNC-SRV-SMH40S-0005-30ABK-4LKH KNC-SRV-SMH40S-0005-30AAK-4DKH	KNC-SRV-SMH40S-0010-30AAK-4LKH KNC-SRV-SMH40S-0010-30ABK-4LKH KNC-SRV-SMH40S-0010-30AAK-4DKH
Length of Motor L (mm)	85.3±1 119±1.5 (with brake)	110.8±1 145±1.5 (with brake)

Motor Cable: MOT-005-05-KL-D for KNC-SRV-SMH40S-0005-30AAK-4DKH, KNC-SRV-SMH40S-0010-30AAK-4DKH

Wire Spec.: 4 x 18AWG(41/0.167)



A
4PIN

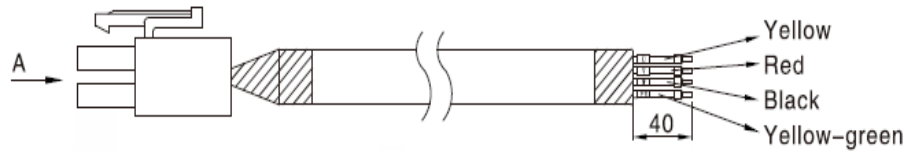

KNC-SRV-MOT-005-LL-KL-D		
Cable Color	Signal	PIN #
Yellow	U	PIN 1
Red	V	PIN 2
Black	W	PIN 3
Yellow-green	PE	PIN 4

Motor Cable: MOT-005-05-KL for KNC-SRV-SMH40S-0005-30AAK-4LKH, KNC-SRV-SMH40S-0010-30AAK-4LKH

Wire spec. UI20328 4C x 18AWG(41/0.16T) black

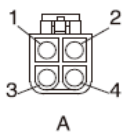

A

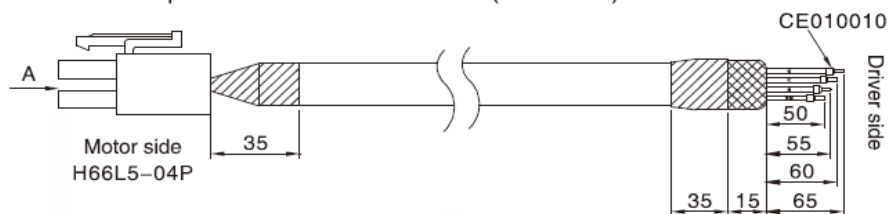

KNC-SRV-MOT-005-LL-KL		
Cable Color	Signal	PIN #
Yellow	U	PIN 1
Red	V	PIN 2
Black	W	PIN 3
Yellow-green	PE	PIN 4

Encoder Cable: ENCAA-05-KH for KNC-SRV-SMH40S-0005-30AAK-4DKH, KNC-SRV-SMH40S-0010-30AAK-4DKH, KNC-SRV-SMH40S-0005-30AAK-4LKH, KNC-SRV-SMH40S-0005-30ABK-4LKH, KNC-SRV-SMH40S-0010-30AAK-4LKH, KNC-SRV-SMH40S-0010-30ABK-4LKH

Wire spec. 1P x 24AWG(7/0.20T)+7P x 28AWG(7/0.127T)

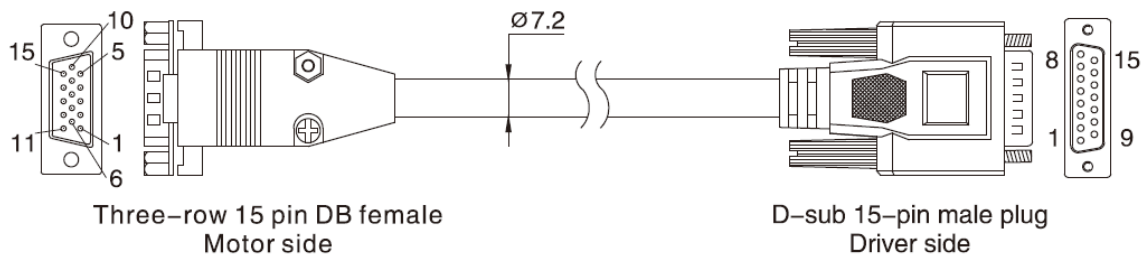

ENCODER PINOUT

KNC-SRV-ENCCA-LL-KH				
Three-row 15 pin DB	Two-row 15 pin DB	Signal	External Wire Color	Motor Wire Color
PIN 1	PIN 1	+5V	Red (thick)	Red
PIN 8	PIN 2	A	Orange	Blue-Black
PIN 7	PIN 3	B	Yellow	Green
PIN 6	PIN 4	Z	Green	Yellow
PIN 4	PIN 5	U	Brown	Brown-Black
PIN 10	PIN 6	V	Purple	White-Black
PIN 9	PIN 7	W	Blue	Gray-Black
PIN 2	PIN 9	GND	Black (thick)	Black
PIN 13	PIN 10	/A	Orange-White	Blue
PIN 12	PIN 11	/B	Yellow-White	Green-Black
PIN 11	PIN 12	/Z	Green-White	Yellow-Black
PIN 5	PIN 13	/U	Brown-White	Brown
PIN 15	PIN 14	/V	Purple-White	White
PIN 14	PIN 15	/W	Blue-White	Gray
PIN 3 empty	PIN 8 empty			
Metal Shell	DB Metal Shell	Shield	Shield	Metal Shell

BRAKE CABLE: KNC-SRV-BRA-05-KL for KNC-SRV-SMH40S-0005-30ABK-4LKH, KNC-SRV-SMH40S-0010-30ABK-4LKH

BRAKE CABLE

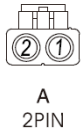

Wire spec. 2 x 20AWG

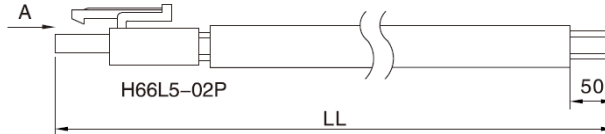

KNC-SRV-BRA-05-KL		
CABLE COLOR	SIGNAL	PIN ASSIGNMENT
RED	BRAKE+	1
BLUE	BRAKE-	2

COMPATIBLE CABLES

Model	Motor Cable	Encoder Cable	Brake Cable
KNC-SRV-SMH40S-0005-30AAK-4LKH	KNC-SRV-MOT-005-05-KL	KNC-SRV-ENCCA-05-KH	--
KNC-SRV-SMH40S-0005-30ABK-4LKH	KNC-SRV-MOT-005-05-KL	KNC-SRV-ENCCA-05-KH	KNC-SRV-BRA-05-KL
KNC-SRV-SMH40S-0005-30AAK-4DKH	KNC-SRV-MOT-005-05-KL-D	KNC-SRV-ENCCA-05-KH	--
KNC-SRV-SMH40S-0010-30AAK-4LKH	KNC-SRV-MOT-005-05-KL	KNC-SRV-ENCAA-05-KH	--
KNC-SRV-SMH40S-0010-30ABK-4LKH	KNC-SRV-MOT-005-05-KL	KNC-SRV-ENCCA-05-KH	KNC-SRV-BRA-05-KL
KNC-SRV-SMH40S-0010-30AAK-4DKH	KNC-SRV-MOT-005-05-KL-D	KNC-SRV-ENCCA-05-KH	--

SPECIFICATIONS

Model	KNC-SRV-SMH40S-0005-30AAK-4LKH KNC-SRV-SMH40S-0005-30ABK-4LKH KNC-SRV-SMH40S-0005-30AAK-4DKH	KNC-SRV-SMH40S-0010-30AAK-4LKH KNC-SRV-SMH40S-0010-30ABK-4LKH KNC-SRV-SMH40S-0010-30AAK-4DKH
Length of Motor L (mm)	85.3±1 119±1.5 (with brake)	110.8±1 145±1.5 (with brake)
Position Feedback Device	Incremental Encoder 2500PPR	
Cooling Method	Totally Enclosed, Non-Ventilated	
Protection Level	IP65 for Body, Shaft Sealing IP54	
Environmental Conditions of Operation	Temperature	-20°C~40°C
	Humidity	Below 90% RH (No Condensing)
	Ambient Environment	Away from active gas, combustible gas, oil drops and dust
	Altitude	Maximum Altitude 4000m, Rated Power at 100m or Below, Above 1000m: Decreasing 1.5% per 100m Rise