

# KNC-PKS-FD322S-02 - Servo System



FEATURES

- 88-126VAC Single-Phase Input Voltage
- Rated Torque of 91 oz-in
- Power Ratings up to 200 Watts
- 2,500 PPR Incremental Encoder
- Maximum Speed of 3000 RPM
- IP65 for Body, IP54 Shaft Seal
- Brake Option Available
- Position, Speed, and Torque Control
- RS232 and RS485 Port



DESCRIPTION

The KNC-PKS-FD322S-02-60S-AAK-AKH Servo System includes a 200 Watt SMH60S-0020 AC Servo Motor operated by the FD322S-LA-000 Drive. These packages are ideal and easy start-ups, convenience, and performance. The Servo Motors included in these packages provide torque up to 91 oz-in. The FD322S-LA-000 Drive offers current forward-feedback control, acceleration forward-feedback control, speed viewer, and inertia viewer; providing for improved response performance. Each system includes a 5m Motor Power Cable and a 5m Encoder Cable.

Item	Rated Voltage (VAC)	Rated Speed (RPM)	Rated Torque (oz-in)	Rated Current (Arms)	Inertia (oz-in-sec <sup>2</sup> )	Torque Constant KT (oz-in/A)	Resistance (ohms)	Inductance (mH)	Brake (24VDC)	Motor Length (mm)	Shaft Diameter (mm)
KNC-PKS-FD322S-02-60S-AAK-AKH	88-126	3000	91	2.7	0.00365	33.98	2.1	4.1	No	120	14
KNC-PKS-FD322S-02-60S-ABK-AKH	88-126	3000	91	2.7	0.00365	33.98	2.1	4.1	Yes	159	14

ORDERING INFORMATION

## PKS-FD322S-02-60S-AAK-AKH

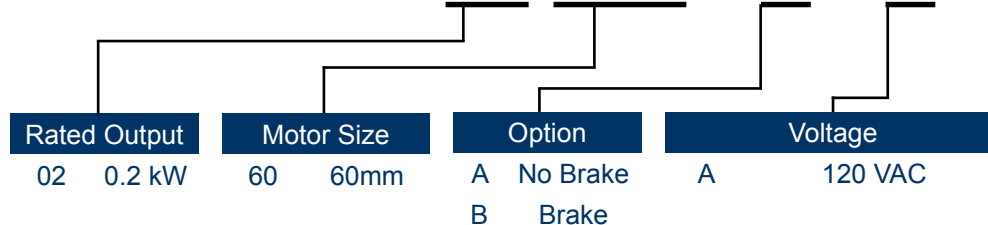

L011522

# SMH60S-0020 Motor Specifications



## FEATURES

- 220 VAC
- 200 W Power Rating
- Rated Torque of 91 oz-in
- Maximum Speed of 3000 rpm
- 2500 PPR Incremental Encoder Attached
- IP65 for Body, IP54 Shaft Seal
- Brake Option Available
- CE Certified



## SPECIFICATIONS

Item	Rated Torque (oz-in)	Rated Power (Watts)	Rated Speed (rpm)	Rated Current (Arms)	Inertia (oz-in-sec <sup>2</sup> )	Torque Constant KT (oz-in/A)	Resistance (ohms)	Inductance (mH)	Length (mm)	Weight (lbs)
SMH60S-0020-30AAK-3AKH	91	200	3000	2.7	0.00531	33.98	2.1	4.1	120	2.86
SMH60S-0020-30ABK-3AKH	91	200	3000	2.7	0.00531	33.98	2.1	4.1	159	3.96

## DIMENSIONS

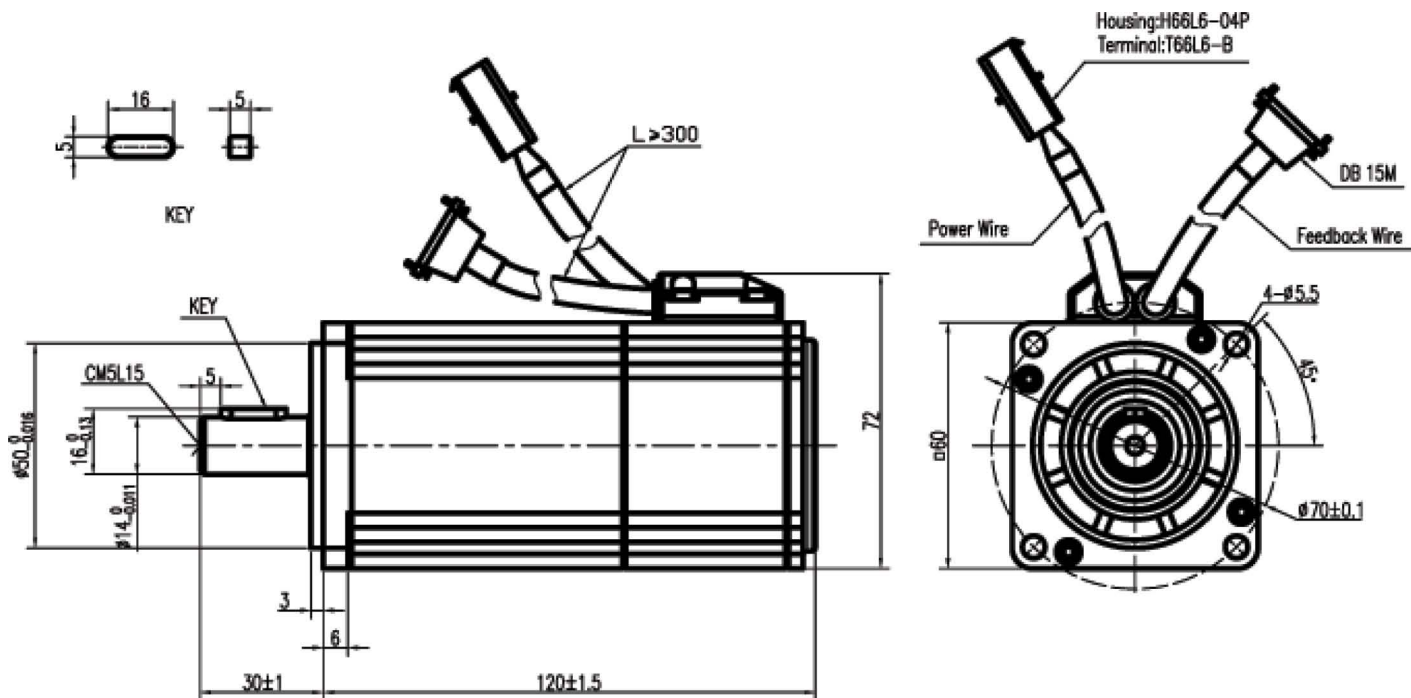

Note: Part Number SMH60S-0020-30ABK is with the brake option. Brake option not shown in above dimensions.

Dimensions are in mm

# FD322S-LA-000 Driver Specifications



## FEATURES

- Input Voltage Range of 88-126VAC
- 200 W Power Rating
- Rated Torque of 91 oz-in
- Maximum Speed of 3000 rpm
- 2500 PPR Incremental Encoder Attached
- IP65 for Body, IP54 Shaft Seal
- Brake Option Available
- CE Certified



## DIMENSIONS

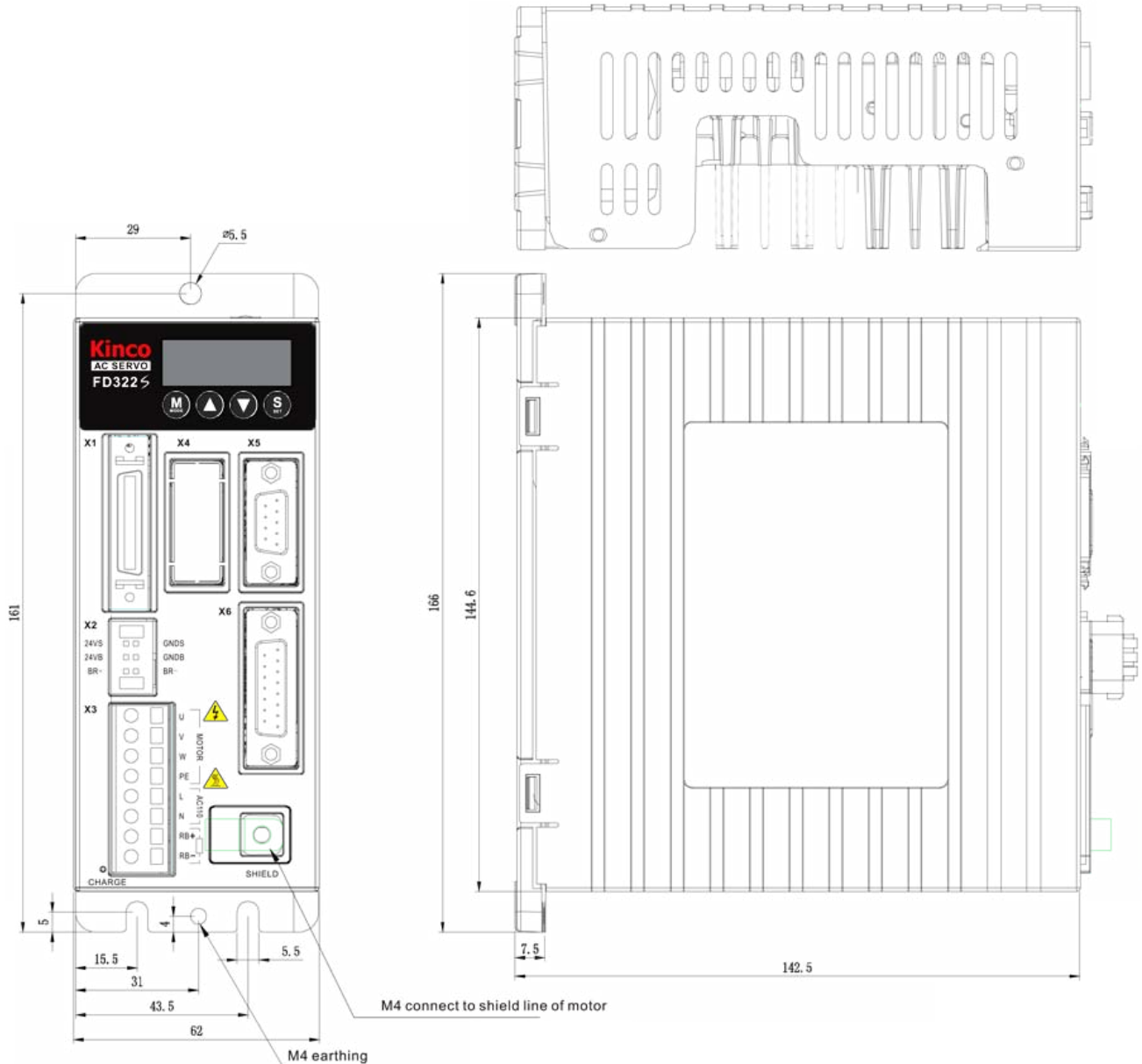

Dimensions are in mm

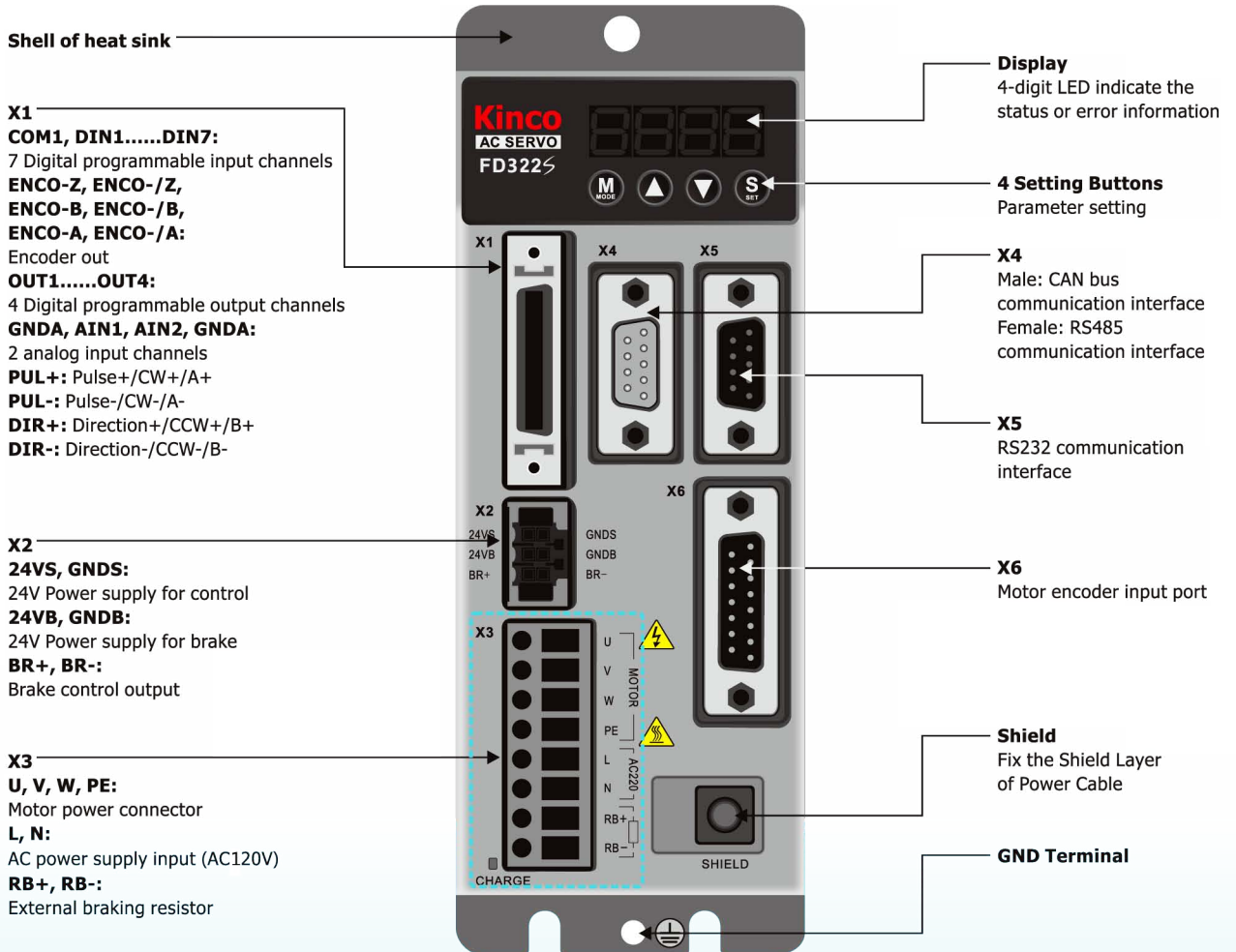



### Digital Input/Output Port

PIN No.	Signal	PIN No.	Signal	PIN No.	Signal	PIN No.	Signal
2	COM1	1	OUT1+	20	NC	19	AIN1
4	DIN1	3	OUT1-	22	NC	21	GNDA
6	DIN2	5	OUT2+	24	GND	23	AIN2
8	DIN3	7	OUT2-	26	ENCO-Z	25	GNDA
10	DIN4	9	OUT3	28	ENCO-/Z	27	PUL+
12	DIN5	11	OUT4	30	ENCO-B	29	PUL-
14	DIN6	13	COM0	32	ENCO-/B	31	DIR+
16	DIN7	15	NC	34	ENCO-A	33	DIR-
18	NC	17	NC	36	ENCO-/A	35	NC

X1

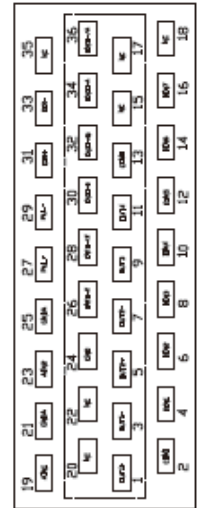

### CAN

PIN Number	Signal
1	NC
2	CAN_L
3	GND
4	NC
5	NC
6	NC
7	CAN_H
8	NC
9	NC

### RS485

PIN Number	Signal
1	NC
2	RX+
3	TX+
4	NC
5	GND
6	+5V
7	RX-
8	TX-
9	NC

X4

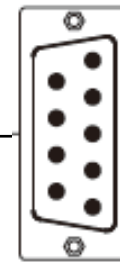

9 Pin DB

### RS232

PIN Number	Signal
1	NC
2	TX
3	RX
4	NC
5	GND
6	NC
7	NC
8	NC
9	NC

\*Note: The CAN option is available only for the AA and the CA versions

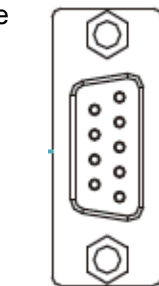

9 Pin DB Female

X5

### ENCODER IN

PIN No.	Incremental Encoder Signal	PIN No.	Incremental Encoder Signal	PIN No.	Communication Encoder Signal	PIN No.	Communication Encoder Signal
1	+5V	9	GND	1	+5V	9	GND
2	A	10	/A	2	NC	10	NC
3	B	11	/B	3	NC	11	NC
4	Z	12	/Z	4	NC	12	NC
5	U	13	/U	5	NC	13	NC
6	V	14	/V	6	NC	14	NC
7	W	15	/W	7	SD	15	/SD
8	PTC_IN			8	NC		

X6

Motor Encoder Input Port

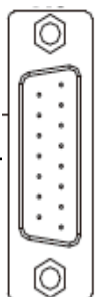

15 Pin DB Female

### Compatible Drivers

Part Number	Description
FD322S-LA-000	Servo Driver



### Compatible Motors

Part Number	Description
SMH60S-0020-30AAK-3AKH	Servo Motor
SMH60S-0020-30ABK-3AKH	Servo Motor



### Compatible Cables

Part Number	Description
KNC-SRV-ENCCA-05-KH	Encoder Cable
KNC-SRV-MOT-005-05-KL	Power Cable

