

BDWG259 Series DC Brush Gearmotor



FEATURES

- DC Brush Worm Gearmotor
- Designed for High-Volume Applications
- Up to 3,540 oz-in of Rated Torque
- 95mm Motor Body Diameter
- 275mm Motor Body Length
- Mounting Screws Included



DESCRIPTION

The BDWG259 Series is designed for high-volume OEM applications with low cost being the primary objective. These reliable low cost Brush DC Worm Gearmotors come in a variety of power levels and sizes, and are fully reversible. The BDWG259 Series is a cost-effective solution to manage motion control in many rotary applications including medical, semiconductor, pumps, robotics, hobby, CNC, and many other applications where a low cost Brush DC Worm Gearmotor is needed.

PART NUMBER BREAKDOWN

Model #	Rated Voltage (V)	Rated Current (A)	Max Current (A)	Rated Speed (RPM)	Rated Torque (oz-in)	Max Torque (oz-in)	IP Rating	Weight (lbs)	Torque Curves*
BDWG259NP-275-12-22-HL-C5-W2	12	12	60	22	2,832	18,410	IP 53	15.8	8
BDWG259NP-275-24-22-HL-C5-W2	24	6	30	22	2,832	18,410	IP 53	15.8	8
BDWG259NC-275-24-22-HL-C5-W2	24	6	30	22	2,832	18,410	IP 53	15.8	8
BDWG259NC-275-12-22-MNB-C8-W1	12	12	60	22	2,832	18,410	IP 53	16.07	8
BDWG259RP-275-24-25-JL-C5-W2	24	7	30	25	3,540	19,118	IP 40	15.8	10
BDWG259NP-275-12-40-HL-C5-W6	12	18	98	40	2,124	16,993	IP 53	15.8	9
BDWG259NP-275-24-40-HL-C5-W6	24	9	49	40	2,124	16,993	IP 53	15.8	9

* See Torque Curves Section

SPECIFICATIONS

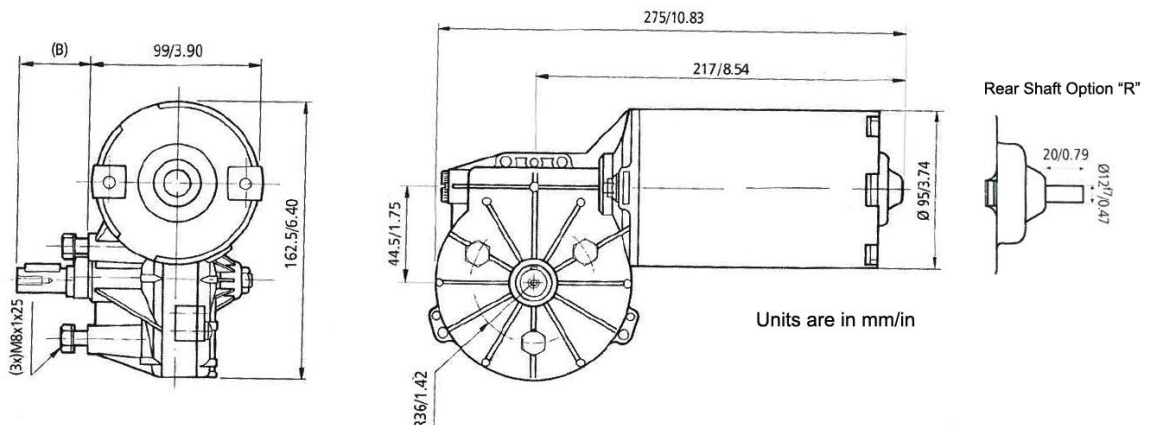

L010801

DIMENSIONS

BDWG259 N P - 275 - 12 - 22 - H L - C5 - W2

Rear Shaft	
N	No Rear Shaft
R	Rear Shaft

Voltage	
12	
24	

RPM	
22	
25	
40	

Output Shaft Direction	
L	Left H Shaft Option
B	Left & Right M & N Shaft Options

Gear Material	
P	Plastic
C	Resin Bonded Fabric
B	Bronze

Front Shaft Options	
M	
N	
H	
J	

Connector/Wiring Options	
C5-W2	Amp Connector, 150mm Length, No Filter
C5-W6	Amp Connector, 150mm Length, Filter
C8-W1	Flying Leads, No Filter, No Connector

SHAFT OPTIONS

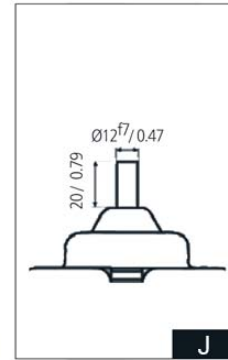
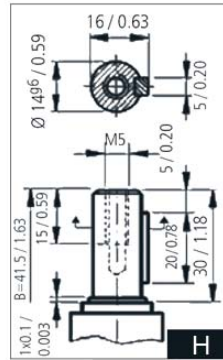
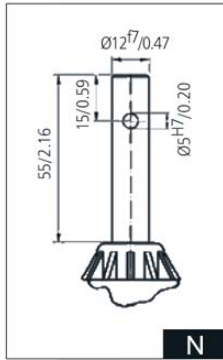
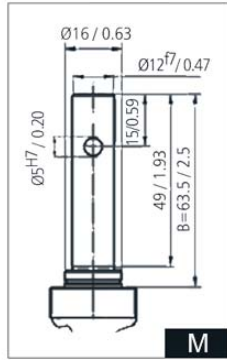

Output Shaft Direction

CONNECTOR OPTIONS

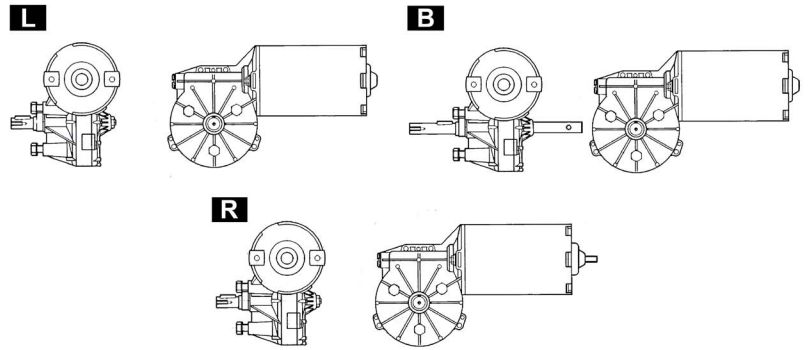
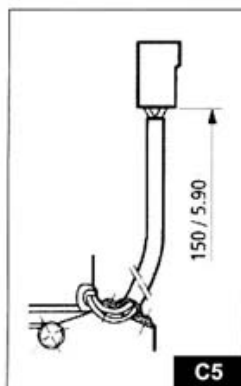
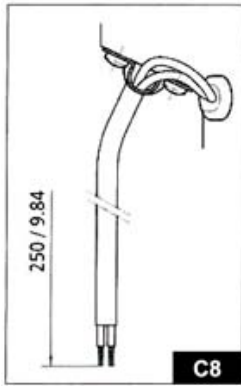

WIRING OPTIONS

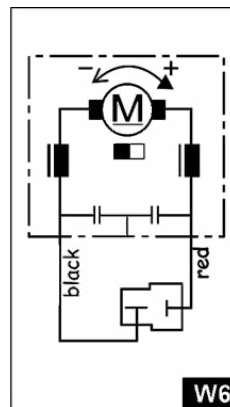
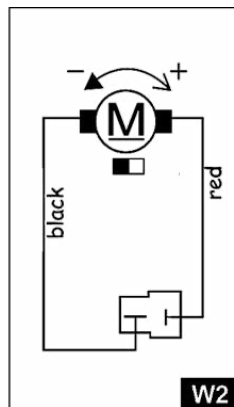
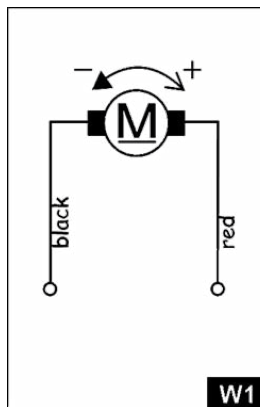

C5 Option Mating Connector:
Plug AMP 180907-0
(2x) Female Terminal 6.35

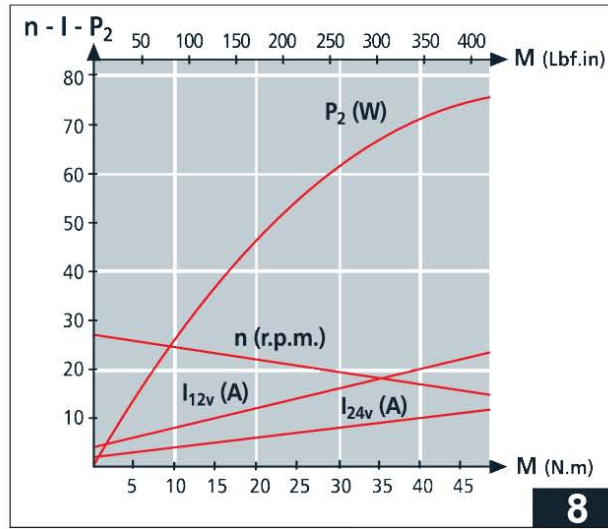

8

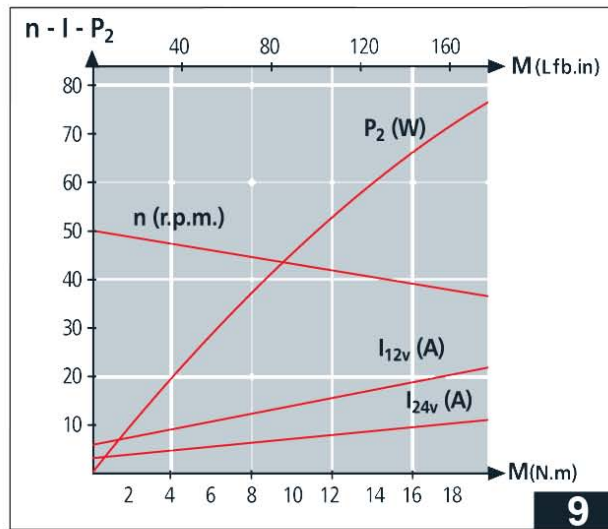

9

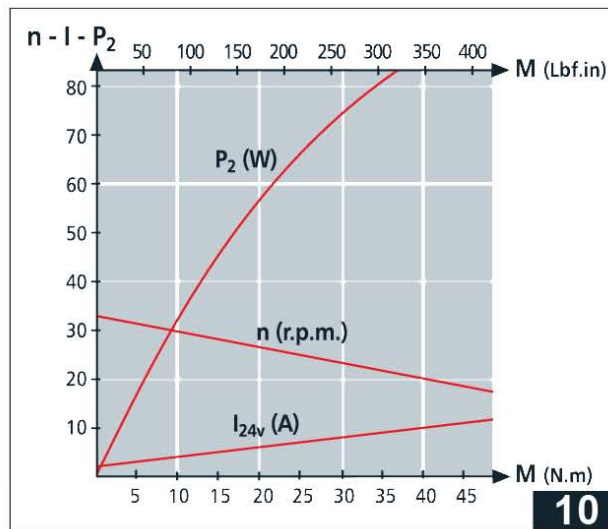

10