

KNC-PKS-FD432S-12 - Servo System



FEATURES

- 176-253VAC
- Rated Torque of 566 oz-in
- Power Ratings up to 1250 Watts
- 2,500 PPR Incremental Encoder
- Maximum Speed of 5800 RPM
- IP65 for Body, IP54 Shaft Seal
- Brake Option Available
- Position, Speed, and Torque Control
- RS232 and RS485 Ports
- Modbus RTU



DESCRIPTION

The KNC-PKS-FD432S-12 Servo System includes a 1250 Watt KNC-SRV-SMH110D-0125-30AAK-4LKC or KNC-SRV-SMH110D-0125-30ABK-4LKC Servo Motor with Brake, operated by the KNC-SRV-FD432S-LA-000 Servo Drive. These packages are ideal and provide easy start-ups, convenience and performance. The Servo Motors included in these packages provide torque up to 566 oz-in. The KNC-SRV-FD432S-LA-000 Servo Drive offers current forward-feedback control, acceleration forward-feedback control, speed viewer and inertia viewer; providing for improved response performance. Each system includes a 5m Motor Power Cable and a 5m Encoder Cable. If purchasing the option with a Brake then a 5m Brake Cable will be included as well.

SPECIFICATIONS

Item	Rated Voltage (VAC)	Rated Speed (RPM)	Rated Torque (oz-in)	Rated Current (Arms)	Inertia (oz-in-sec ²)	Torque Constant KT (oz-in/A)	Resistance (ohms)	Inductance (mH)	Brake (24VDC)	Motor Length (mm)	Shaft Diameter (mm)
KNC-PKS-FD432S-12-H11D-AAK-LKC	176-253	3000	566	6.5	0.0828	106	0.8	6.4	No	168	19
KNC-PKS-FD432S-12-H11D-ABK-LKC	176-253	3000	566	6.5	0.0828	106	0.8	6.4	Yes	228	19

L011759

SMH110D-0125 Motor Specifications



FEATURES

- 220VAC
- 1250 W Power Rating
- Rated Torque of 566 oz-in
- Maximum Speed of 5800 rpm
- 2500 PPR Incremental Encoder Attached
- IP65 for Body, IP54 Shaft Seal
- Brake Option Available
- CE Certified



SPECS

Item	Rated Torque (oz-in)	Rated Power (Watts)	Rated Speed (rpm)	Rated Current (Arms)	Inertia (oz-in-sec ²)	Torque Constant KT (oz-in/A)	Resistance (ohms)	Inductance (mH)	Length "L" (mm)	Weight (lbs)
KNC-SRV-SMH110D-0125-30AAK-4LKC	566	1250	3000	6.5	0.0828	106	0.8	6.4	168	13.67
KNC-SRV-SMH110D-0125-30ABK-4LKC	566	1250	3000	6.5	0.0828	106	0.8	6.4	228	18.08

DIMENSIONS

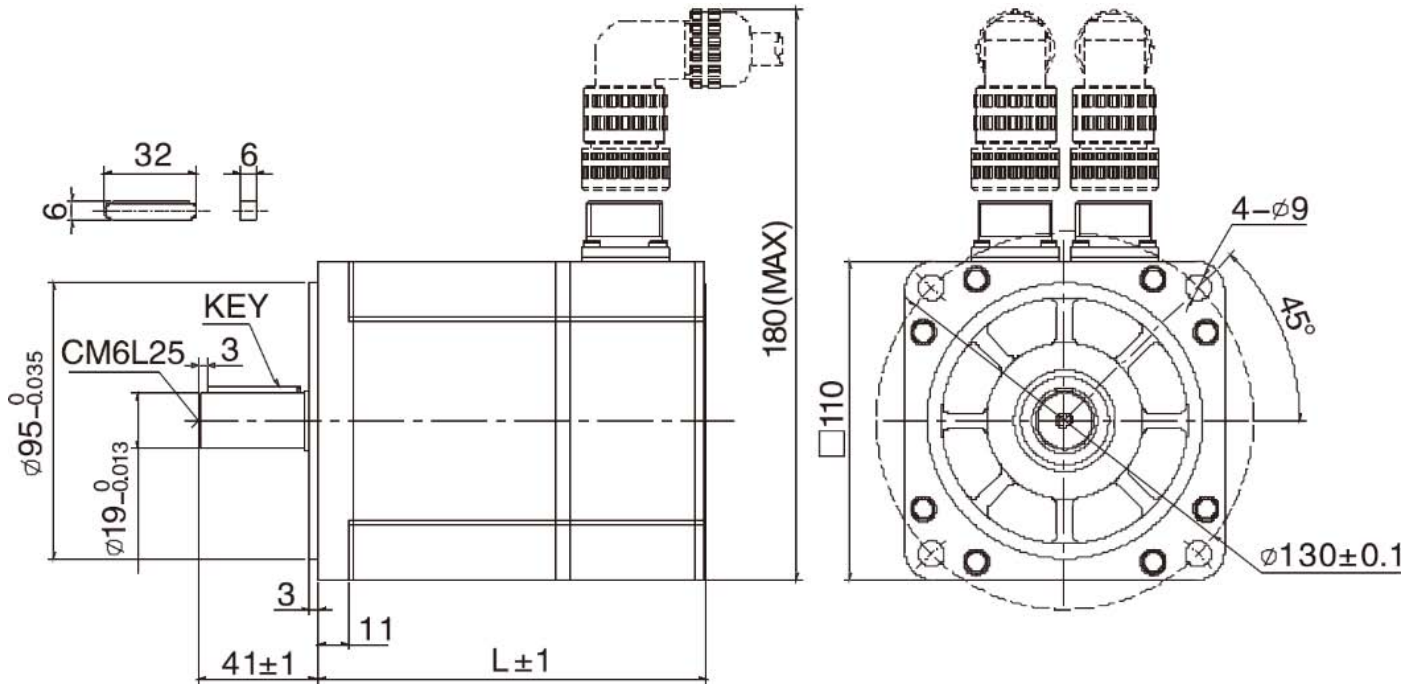

Note: All Dimensions in (mm)

FD432S-LA-000 Driver Specifications



FEATURES

- 176-253VAC Single or Three-Phase Input
- 1000-1260 Watt Power Range
- Position, Speed and Torque Control
- RS232 and RS485 Port
- Communication Protocol: MODBUS
- Requires 2500 PPR Encoder Input
- 7 Inputs, 4 Outputs
- CE Certified



DIMENSIONS

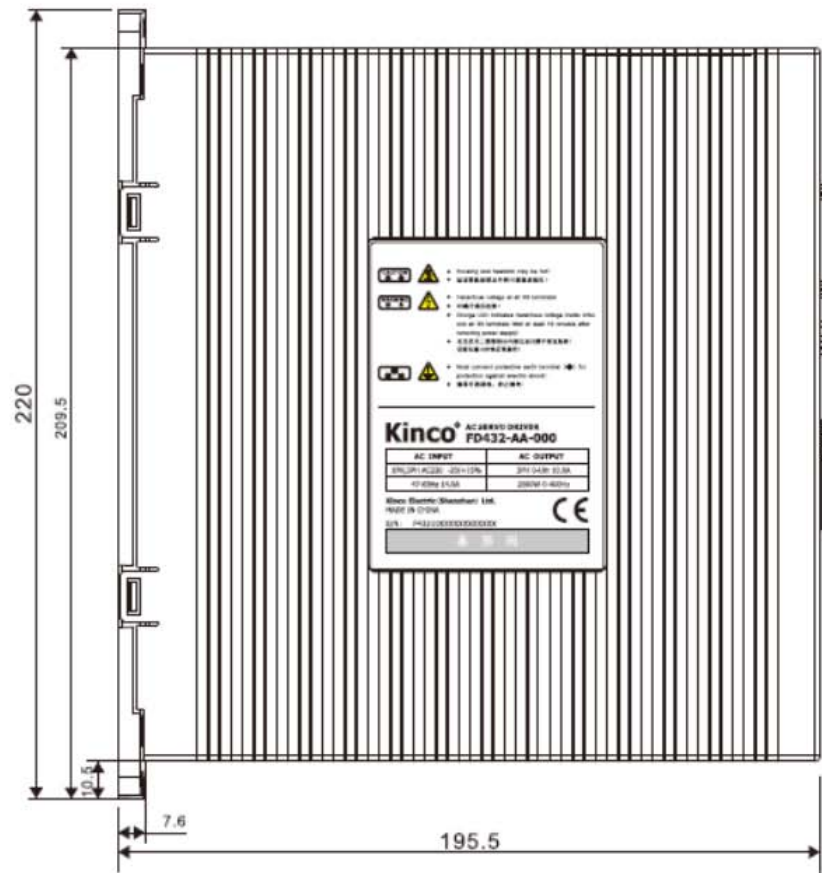
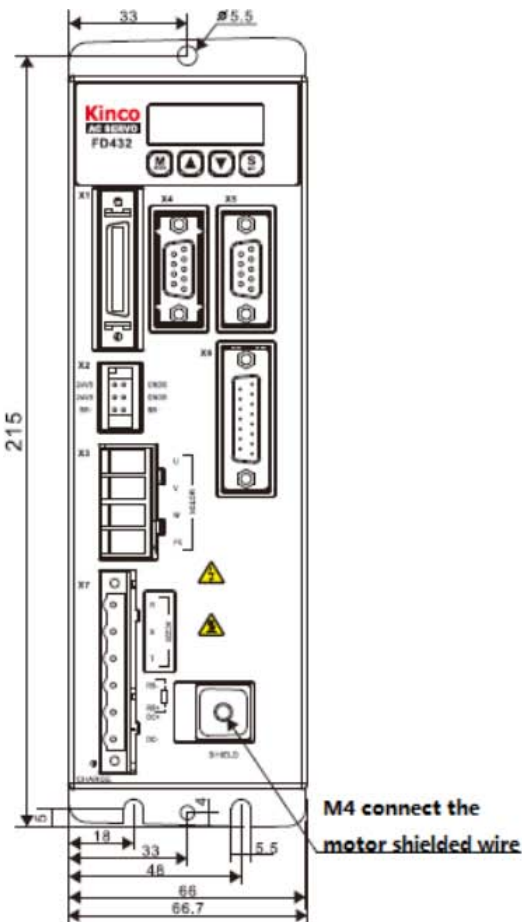

Note: All Dimensions in (mm)

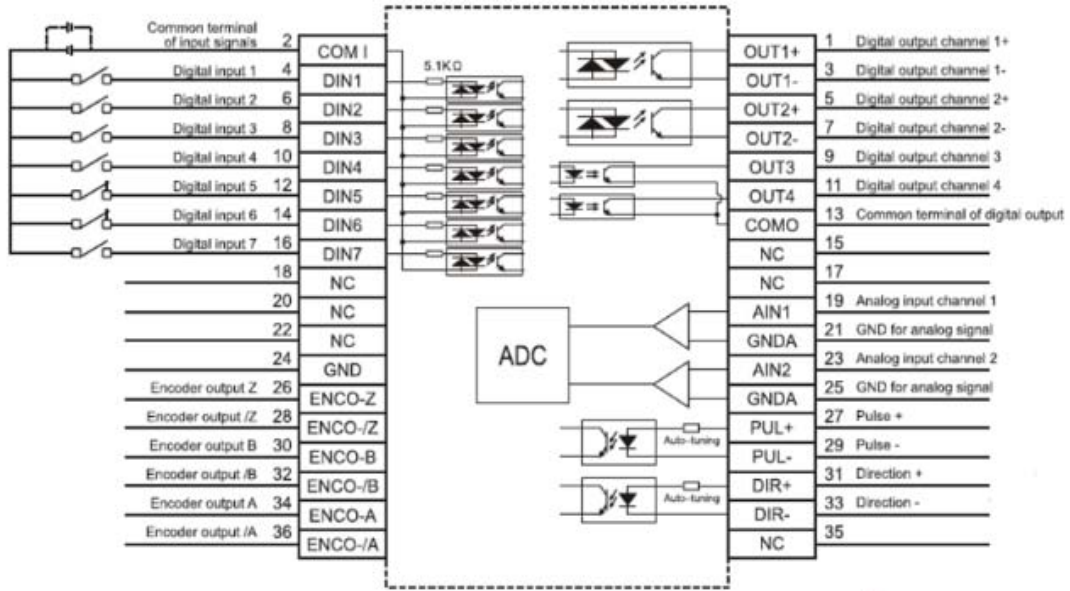

X1

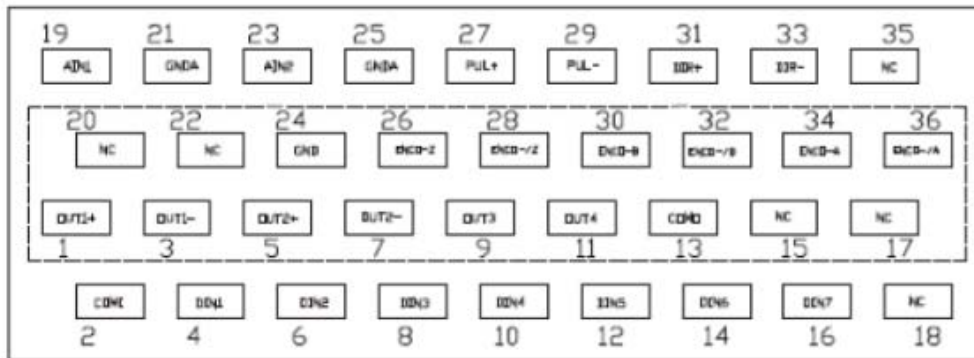

Pin #	Signal	Pin #	Signal	Pin #	Signal	Pin #	Signal
2	COM1	1	OUT1+	20	NC	19	AIN1
4	DIN1	3	OUT1-	22	NC	21	GNDA
6	DIN2	5	OUT2+	24	GND	23	AIN2
8	DIN3	7	OUT2-	26	ENCO-Z	25	GNDA
10	DIN4	9	OUT3	28	ENCO-/Z	27	PUL+
12	DIN5	11	OUT4	30	ENCO-B	29	PUL-
14	DIN6	13	COM0	32	ENCO-/B	31	DIR+
16	DIN7	15	NC	34	ENCO-A	33	DIR-
18	NC	17	NC	36	ENCO-/A	35	NC

RS485

PIN Number	Signal
1	NC
2	RX+
3	TX+
4	NC
5	GND
6	+5V
7	RX-
8	TX-
9	NC

CAN

PIN Number	Signal
1	NC
2	CAN_L
3	GND
4	NC
5	NC
6	NC
7	CAN_H
8	NC
9	NC

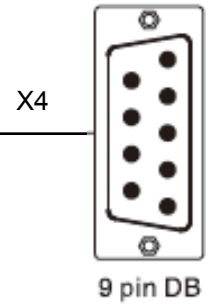
RS232

PIN Number	Signal
1	NC
2	TX
3	RX
4	NC
5	GND
6	NC
7	NC
8	NC
9	NC

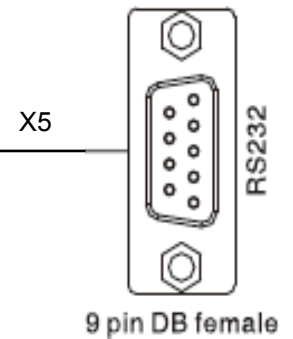

PIN No.	Signal	PIN No.	Signal
1	+5V	9	GND
2	A	10	/A
3	B	11	/B
4	Z	12	/Z
5	U	13	/U
6	V	14	/V
7	W	15	/W
8	PTC_IN		

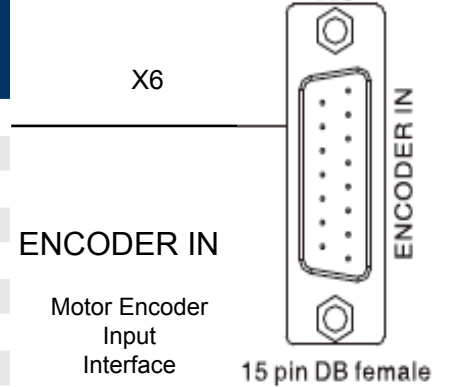

Operation Environment	Operating Temperature	0 ~ 40°C
	Storage Temperature	-10° C~70°C
	Humidity (Non-Condensing)	Below 90%RH
	Protection Class	IP20
	Installation Environment	Installed in a Dust-Free, Dry and Lockable Environment (Such as in a Electrical Cabinet)
	Installation Mode	Vertical Installation
	Altitude	No Power Limitation Below 1000m
	Atmospheric Pressure	86kpa-106kpa

Model Parameter		KNC-SRV-FD432S-LA-000
Power	Main Supply Voltage	Single-Phase or Three-Phase AC220V -20/+15% 47~63Hz
	Control Circuit Voltage	18VDC~30VDC 1A
Current	Rated Current (RMS)	10A
	Peak Current (PEAK)	27.5A
Feedback Signal		2500PPR (Incremental Encoder with 5V Supply)
Brake Chopper		Use an External Braking Resistor According to Application, Mainly in Occasion of Quick Stop
Brake Chopper Threshold		DC380V ± 5V
Over-Voltage Alarming Threshold		DC400V ± 5V
Under-Voltage Alarming Threshold		DC200V ± 5V
Cooling Method		Fan
Weight		2.4 Kg
Digital Input	Input Specification	7 Digital Inputs, with COM1 Terminal for PNP (High Level Valid 12.5-30V) or NPN (Low Level Valid) Connection.
	Input Function	Define Freely According to Requirement, Supporting Following Functions: Driver Enable, Driver Fault Reset, Driver Mode Control, Proportional Control, Positive Limit, Negative Limit, Homing Signal, Reverse Command, Internal Speed Section Control, Internal Positive Section Control, Quick Stop, Start Homing, Active Command, Switch Electronic Gear Ratio, Switch Gain.
Digital Output	Output Specification	4 Digital Outputs, OUT1-OUT4 Current is 100mA, BR+/BR- (Brake Control Output) Current is 500mA, Can Drive Brake Device Directly)
	Output Function	Define Freely According to Requirement, Supporting Following Functions: Driver Ready, Driver Fault, Position Reached, Motor at Zero Speed, Motor Brake, Motor Speed Reached, Z Signal, Maximum Speed Obtained in Torque Mode, Motor Brake, Position Limiting, Reference Found, Multi-Position Reached
	Analog Input	2 Analog Input Can Be Used to Control Speed and Torque, the Input Range is - 10V~10V
	Encoder Signal Output	Output the Encoder Signal of Motor, Used in Multiple Axis Synchronous Control, Supports 2MHz at Most
	RS232	The Max. Baudrate is 115.2KHz, Use JD-PC Software to communicate with PC, or Via Free Protocol to communicate with controller.
	Protection Functions	Over-Voltage Protection, Under-Voltage Protection, Motor Over-Heat Protection (I ² T), Short-Circuit Protection, Drive Over-Heat Protection, Etc.
	RS485	The Max. 115.2KHz, use Modbus RTU protocol to communicate with controller

Compatible Drivers

Part Number	Description
KNC-SRV-FD432S-LA-000	Servo Driver



Compatible Motors

Part Number	Description
KNC-SRV-SMH110D-0125-30AAK-4LKC	Servo Motor
KNC-SRV-SMH110D-0125-30ABK-4LKC	Servo Motor



Compatible Cables

Part Number	Description
KNC-SRV-MOT-008-05-KC1	Power Cable
KNC-SRV-MOT-008-05-KC2-B	Power Cable with Brake
KNC-SRV-ENCCA-05-KC1	Encoder Cable

