

FEATURES

- **DC Brush Motor**
- **60mm Diameter**
- **Up to 25.49 oz-in of Torque**
- **Designed for High-Volume Applications**
- **Custom Versions Available**
- **ISO & TS Automotive Certified**



DESCRIPTION

Anaheim Automation's DC motors provide a cost effective solution for your application. The BDC-162-N-12 series can be used in many applications such as robotics and medical applications. The BDC-162-N-12 series has strong permanent magnets to provide up to 25.49 oz-in of torque. At rated voltage this motor will run up to 3500RPM. Cooling vents on the motor casing are placed optimally for internal cooling of the motor.

SPECIFICATIONS

Model #	No load Speed (RPM)	Rated Speed (RPM)	Rated Current (A)	Starting Current (A)	Rated Torque (oz-in)	Starting Torque (oz-in)	Rated Voltage (VDC)	Approx Weight (lbs)
BDC-162-N-12-3500-Q-C0-W2	3500	2800	7.5	33	25.49	141.62	12	2.95
BDC-162-N-24-2000-X-CI-WA	2000	1500	2.5	8.5	25.49	113.3	24	2.95
BDC-162-N-24-3500-Q-C0-W2	3500	3000	4	18	28.32	141.62	24	2.95
BDC-162-R-24-3500-Z1-C0-W2	3500	3000	4	18	28.32	141.61	24	2.95

ORDERING INFORMATION

BDC-162-N-12-3500-Q-C0-W2

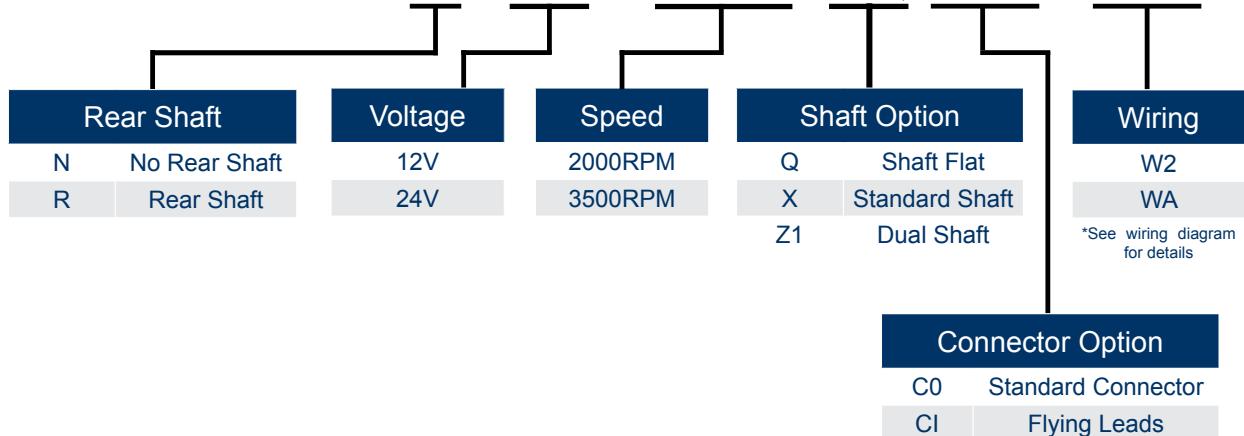

L011091

DIMENSIONS

N-Single Shaft Option

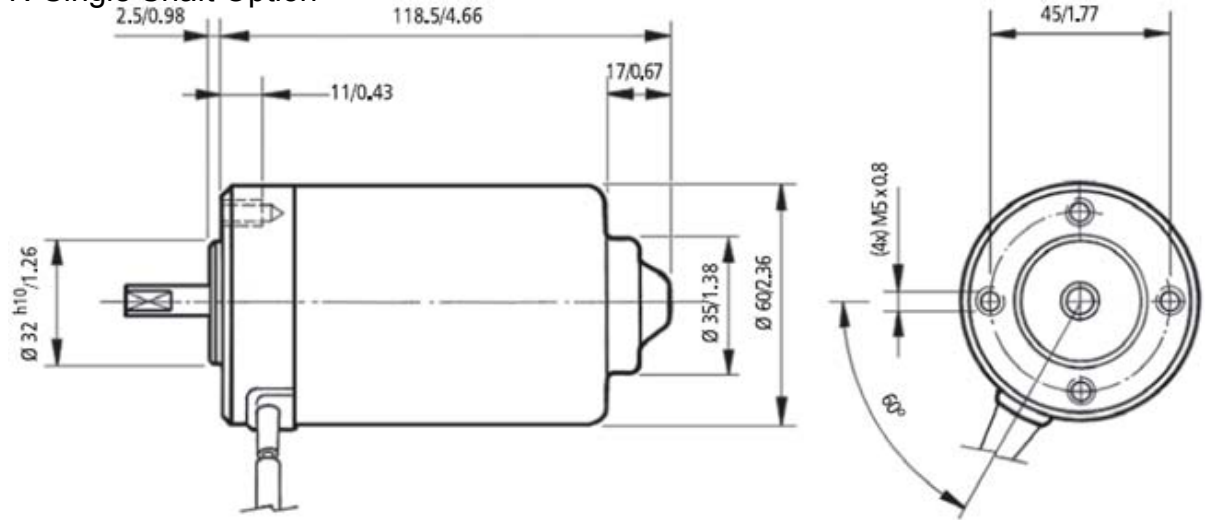

R-Dual Shaft Option

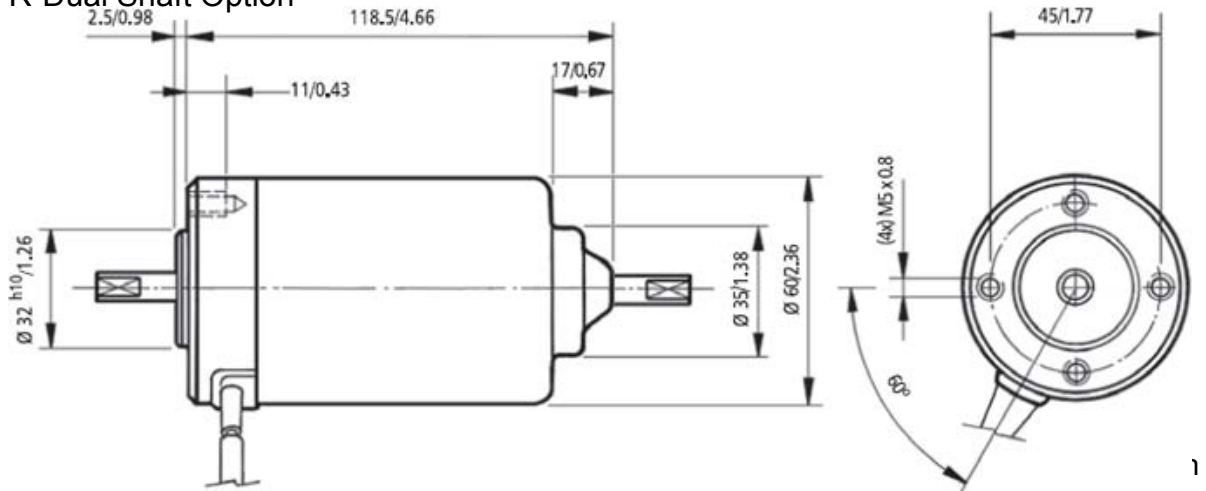

SHAFT OPTIONS

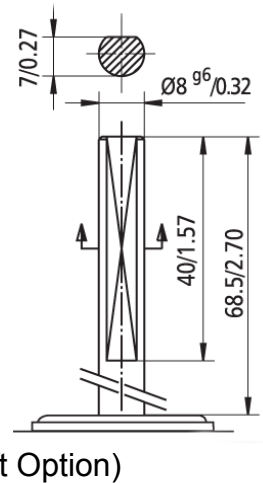
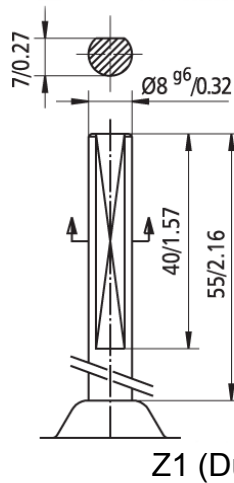
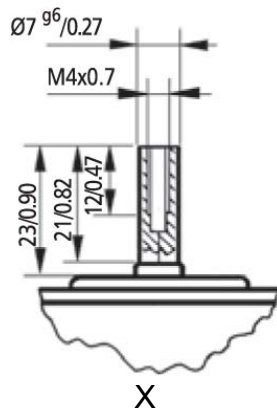
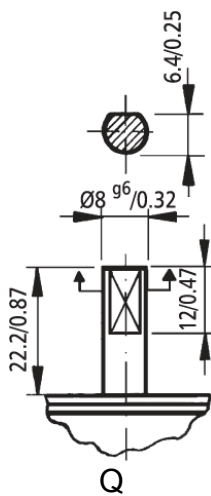

CONNECTOR/WIRING OPTIONS

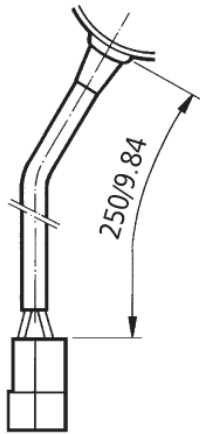

C0

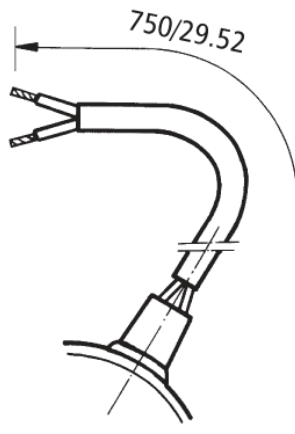

CI

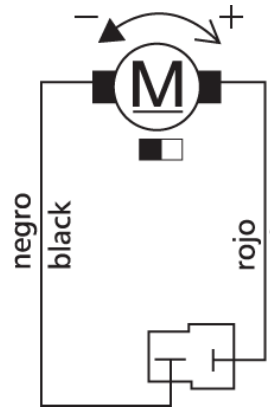

W2

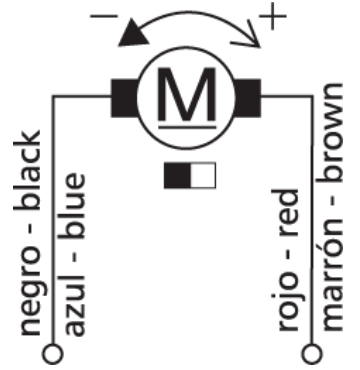

WA

TORQUE CURVE

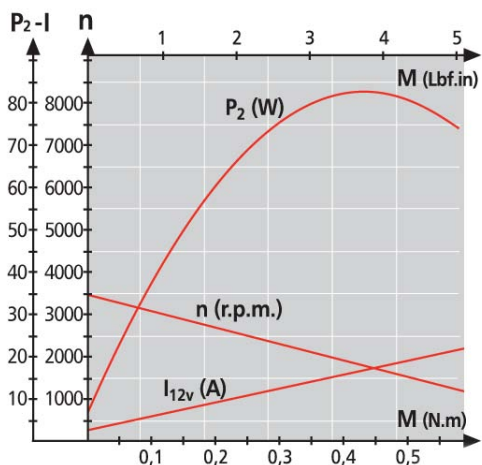

BDC-162-N-12-3500-Q-C0-W2

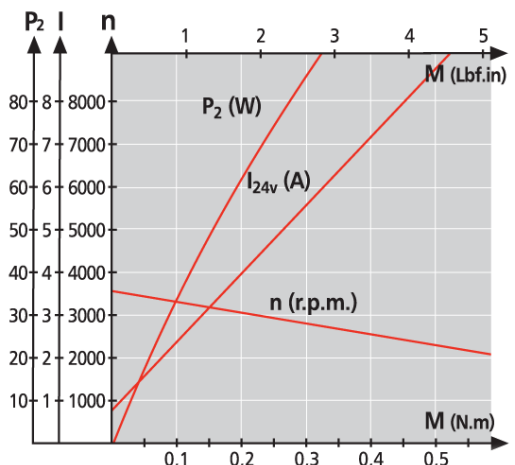

BDC-162-N-24-3500-Q-C0-W2
BDC-162-R-24-3500-Z1-C0-W2

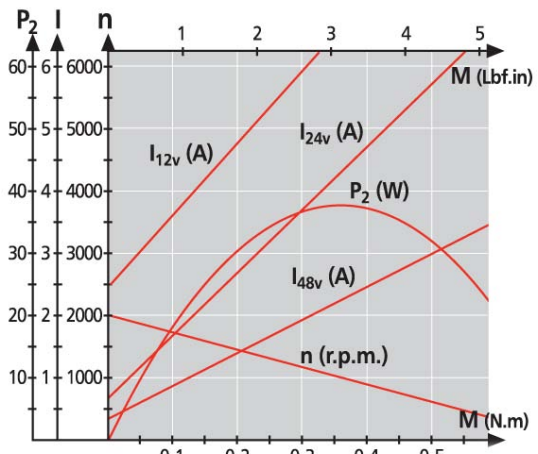

BDC-162-N-24-1500-X-CI-WA