

BLWS23 Series - Brushless DC Motors

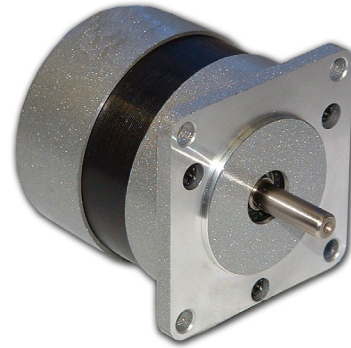

FEATURES

- **NEMA Size 23 BLDC Motors**
- **Compact Size and Power Density**
- **Cost-Effective Solution**
- **Long Life and Highly Reliable**
- **Can be Customized for**
 - **Maximum Speed**
 - **Winding Current**
 - **Shaft Options**
 - **Cables and Connectors**
- **CE Certified and RoHS Compliant**



DESCRIPTION

The BLWS23 Series Brushless DC Motors come in a compact package with high power density. These motors are cost-effective solutions to many velocity control applications. They come in five different stack lengths to provide you with just the right torque for your application. The motors come in a standard 8-lead configuration. We can also customize the windings to perfectly match your voltage, current, and maximum operating speed. Special shaft modifications, cables and connectors are also available upon request.

SPECIFICATIONS

Model #	Rated Voltage (V)	Rated Speed (RPM)	Rated Power (W)	Rated Torque (oz-in)	No Load Current (A)	Torque Constant (oz-in/A)	Back EMF Voltage (V/kRPM)	Line to Line Resistance (ohms)	Line to Line Inductance (mH)	Rotor Inertia (oz-in-sec ²)	Weight (lbs)	"L" Length (in)
BLWS231D-24V-2000	24	2000	11.5	7.8	0.40	9.63	5.10	6.20	12.70	0.00042	0.84	1.72
BLWS231S-24V-2000	24	2000	11.5	7.8	0.40	9.63	5.10	6.20	12.70	0.00042	0.84	1.72
BLWS231D-36V-4000	36	4000	23	7.79	0.20	7.50	5.50	4.20	9.70	0.00042	0.84	1.72
BLWS231S-36V-4000	36	4000	23	7.79	0.20	7.50	5.50	4.20	9.70	0.00042	0.84	1.72
BLWS232D-12V-500	12	255	1.3	7.08	0.18	27.33	16.10	22.00	56.00	0.00106	1.10	2.11
BLWS232S-12V-500	12	255	1.3	7.08	0.18	27.33	16.10	22.00	56.00	0.00106	1.10	2.11
BLWS232D-12V-9700	12	9700	101	14.1	3	1.13	0.42	0.04	0.21	0.00106	1.10	2.11
BLWS232S-12V-12000	12	12000	95	14.1	3	1.13	0.42	0.04	0.21	0.00106	1.10	2.11
BLWS232D-24V-1350	24	1350	16	15.58	0.30	16.43	9.50	6.88	18.00	0.00106	1.10	2.11
BLWS232S-24V-1350	24	1350	16	15.58	0.30	16.43	9.50	6.88	18.00	0.00106	1.10	2.11
BLWS232D-24V-4000	24	4000	46	15.58	0.50	5.48	4.00	0.82	2.30	0.00106	1.10	2.11
BLWS232S-24V-4000	24	4000	46	15.58	0.50	5.48	4.00	0.82	2.30	0.00106	1.10	2.11
BLWS232D-36V-4000	36	4000	4	14.16	0.40	8.50	4.50	2.40	4.39	0.00106	1.10	2.11
BLWS232S-36V-4000	36	4000	4	14.16	0.40	8.50	4.50	2.40	4.39	0.00106	1.10	2.11
BLWS232S-47V-12000	47	12000	125	14	1.5	4.11	3	0.24	0.24	0.00106	1.10	2.11
BLWS232D-48V-4000	48	4000	46	16	0.50	12.04	6.30	3.85	8.7	0.00106	1.10	2.11
BLWS233D-24V-4000	24	4000	92	31.15	0.50	6.09	3.50	0.35	1.00	0.00169	1.65	2.90
BLWS233S-24V-4000	24	4000	92	31.15	0.50	6.09	3.50	0.35	1.00	0.00169	1.65	2.90
BLWS233D-36V-4000	36	4000	92	31.15	0.50	8.92	4.80	0.58	2.10	0.00169	1.65	2.90
BLWS233S-36V-4000	36	4000	92	31.15	0.50	8.92	4.80	0.58	2.10	0.00169	1.65	2.90
BLWS233D-48V-4000	48	4000	92	31	0.50	11.6	6.1	1.2	4	0.00169	1.54	2.90
BLWS234D-24V-4000	24	4000	134	45	0.70	5.62	3.1	0.19	0.61	0.00245	2.20	3.69
BLWS234D-36V-4000	36	4000	134	45.32	0.50	8.50	4.80	0.45	1.50	0.00245	2.20	3.69
BLWS234S-36V-4000	36	4000	134	45.32	0.50	8.50	4.80	0.45	1.50	0.00245	2.20	3.69
BLWS234D-45V-1400	45	1400	44	42.48	0.50	28.32	16.00	4.20	15.00	0.00245	2.20	3.69
BLWS234S-45V-1400	45	1400	44	42.48	0.50	28.32	16.00	4.20	15.00	0.00245	2.20	3.69
BLWS235D-24V-500	24	240	5.7	31.86	0.15	59.48	34.10	18.00	55.00	0.00326	2.76	4.47
BLWS235S-24V-500	24	240	5.7	31.86	0.15	59.48	34.10	18.00	55.00	0.00326	2.76	4.47
BLWS235D-24V-4000	24	4000	184	62	0.9	5.52	3.20	0.2	0.435	0.00326	2.76	4.56

L010229 Note: The 8th character "S" denotes a single shaft, use "D" for double shaft. Custom leadwires, cables, connectors, and windngs are available upon request.

BLWS23 Series - Brushless DC Motors

SPECIFICATIONS

Model #	Rated Voltage (V)	Rated Speed (RPM)	Rated Power (W)	Rated Torque (oz-in)	No Load Current (A)	Torque Constant (oz-in/A)	Back EMF Voltage (V/kRPM)	Line to Line Resistance (ohms)	Line to Line Inductance (mH)	Rotor Inertia (oz-in-sec ²)	Weight (lbs)	"L" Length (in)
BLWS235S-24V-4000	24	4000	184	62	0.9	5.52	3.2	0.2	0.435	0.00326	2.76	4.47
BLWS235D-36V-4000	36	4000	184	62.31	0.40	8.92	4.60	0.38	1.00	0.00326	2.76	4.47
BLWS235S-36V-4000	36	4000	184	62.31	0.40	8.92	4.60	0.38	1.00	0.00326	2.76	4.47
BLWS235D-36V-10000	36	10000	183	24.78	1.50	4.53	2.30	0.09	0.25	0.00326	2.76	4.47
BLWS235S-36V-10000	36	10000	183	24.78	1.50	4.53	2.30	0.09	0.25	0.00326	2.76	4.47
BLWS235D-160V-3000	160	3000	157	70.80	0.20	46.73	26.00	11.00	33.50	0.00326	2.76	4.47
BLWS235S-160V-3000	160	3000	157	70.80	0.20	46.73	26.00	11.00	33.50	0.00326	2.76	4.47

Note: The 8th character "S" denotes a single shaft, use "D" for double shaft. Custom leadwires, cables, connectors, and windngs are available upon request.

SPECIFICATIONS / WIRING

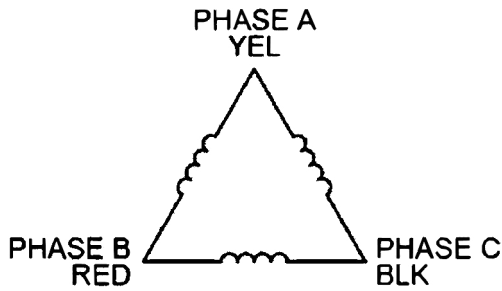

Wire Color	Description
Red	Hall Supply
Blue	Hall A
Green	Hall B
White	Hall C
Black	Hall Ground
Yellow	Phase A
Red	Phase B
Black	Phase C

Hall Sensor Specifications	
Supply Voltage:	4.5VDC to 28VDC
Current, I _{off} :	10mA max
Current, I _{on} :	11.3mA max
Rated Sinking Current:	20mA
Saturation Voltage:	0.4VDC max @ 25°C
Output Leakage Current:	10µA
Output Switching Time @ 25°C	
Rise, 10% to 90%	1.5µs
Fall, 90% to 10%	1.5µs
Output Type:	Open Collector

Winding Type:	Delta, 4 Poles	Max. Radial Force:	75N @ 20mm from the Flange
Hall Effect Angle:	120 Degree Electrical Angle	Max. Axial Force:	10N
Shaft Run Out:	0.025mm	Insulation Class:	Class B
Radial Play:	0.02mm@450g	Dielectric Strength:	500VDC for one Minute
End Play:	0.08mm@450g	Insulation Resistance:	100MOhm, 500VDC

SINGLE SHAFT DIMENSIONS

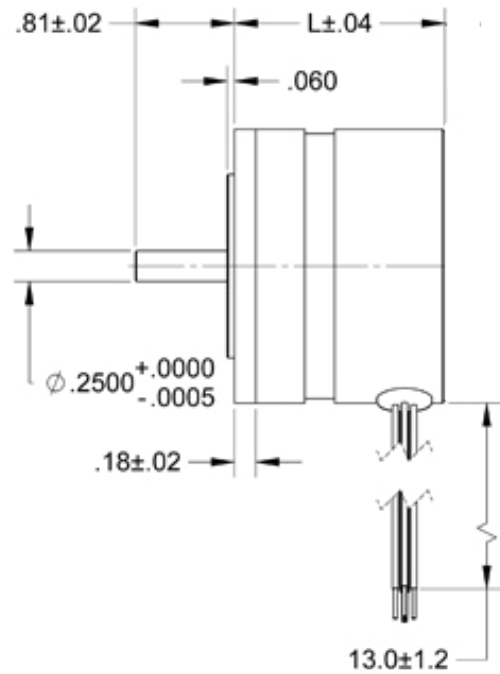
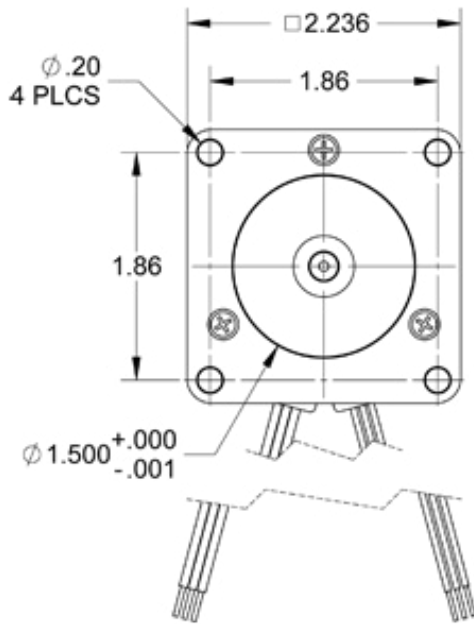

All units are in Inches

DUAL SHAFT DIMENSIONS

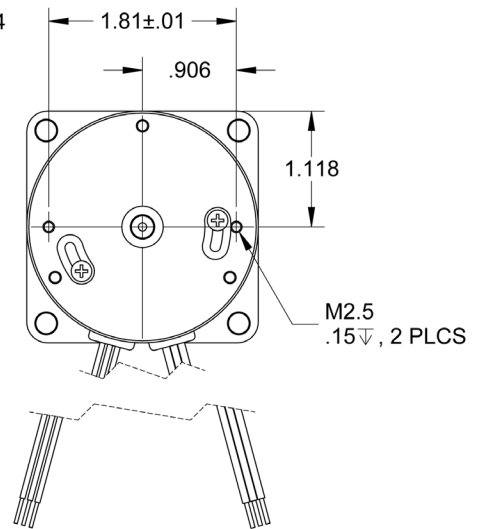
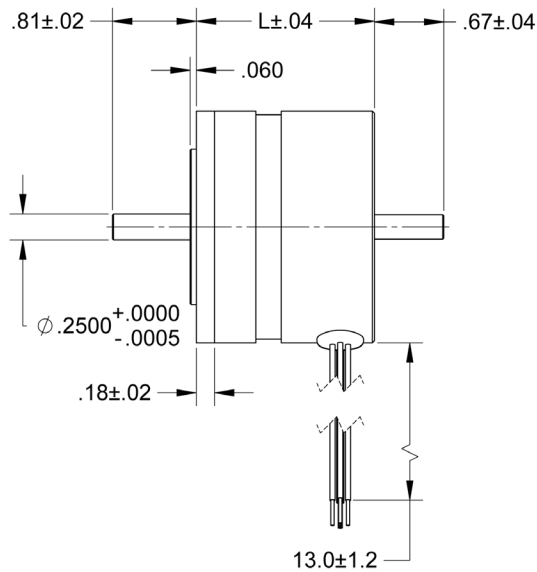
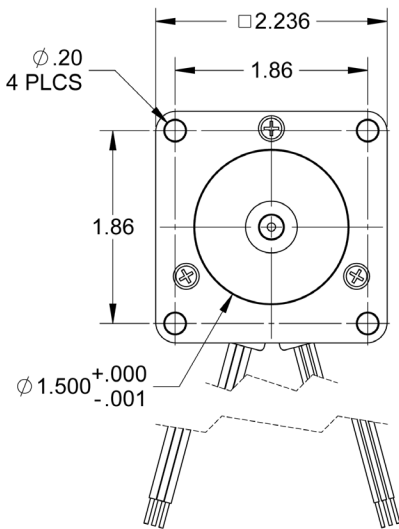

All units are in Inches

