

# BLY17MDC Series Programmable Brushless DC Motor Controller

## User's Guide



**ANAHEIM AUTOMATION**

4985 E Landon Drive, Anaheim, CA 92807  
e-mail: [info@anaheimautomation.com](mailto:info@anaheimautomation.com)

(714) 992-6990 fax: (714) 992-0471  
website: [www.anaheimautomation.com](http://www.anaheimautomation.com)

# Table of Contents

<b>Section 1: Introduction</b> .....	<b>3</b>
Description.....	3
Methods of Communication.....	3
Baud Rate.....	3
Electrical Specifications.....	4
Ordering Information.....	4
Dimensions.....	5
Wiring Diagrams .....	5
Torque Curves .....	6
No Load Acceleration .....	6
<b>Section 2: Functions</b> .....	<b>7</b>
PI Control Tuning.....	8
<b>Section 3: BMC100 Software</b> .....	<b>9</b>
Installation .....	9
Getting Started .....	9
<b>Section 4: Direct Talk Mode</b> .....	<b>12</b>
Command Format.....	12
Unit Selection .....	12
Command Summary.....	12
<b>Section 5: Troubleshooting</b> .....	<b>19</b>
Error Codes .....	19
<b>Appendix 1: ASCII Table for Direct Mode</b> .....	<b>20</b>
<b>Appendix 2: Firmware Revisions</b> .....	<b>20</b>

## Section 1: Introduction

The BLY17MDC Series is a compact microcontroller-based Programmable Brushless DC Motor Controller with Hall Effect Sensor Feedback for accurate speed measurement. With the motor and its respective controller/driver in a single package, the task of wiring up the motor has been eliminated. This motor controller provides flexible, independent control of a Brushless DC motor from computers, or any machine controller with serial communication. It is also capable of standalone operation, making it an embedded machine controller. The easy-to-use Windows software, BMC100, can be used to directly control the BLY17MDC for Real Time Motion through serial communication.

The BLY17MDC Series has an easy-to-remember set of commands for direct control. The controller communicates via two-wire RS485 which is a preferred interface for communication in environments where a substantial amount of electromagnetic noise is present. In addition, the user can easily connect the controller to a PC by using an RS485-to-USB adapter in order to take advantage of the included software.

### Description

The BLY17MDC Series provides accurate control of motor speed, direction, and brake setting for a Brushless DC Motor. The BLY17MDC Series controllers are embedded with a Proportional-Integrator (PI) controller program. Proportional and Integrator Constants,  $K_p$  and  $K_i$ , can be programmed using the BMC100 Windows Software or in Direct Talk Mode through a terminal program. The controller has two modes through which it can control the speed of the motor: Analog Mode and Digital Mode. In Digital Mode, the controller is very accurate in keeping the motor running at the desired speed. The Analog Mode provides standalone functionality to the controller with a dynamic DC voltage input to control the speed of the motor. An analog voltage can be used to set the desired speed between the upper and lower programmable limits. Such a functionality can be easily achieved by using a potentiometer and the 5V output of the controller

### Methods of Communication

There are two methods for sending commands to the BLY17MDC Series. One is to directly talk to the BLY17MDC Series using Direct Talk Mode via the controller's RS485 serial interface. Note that an RS485-to-USB adaptor can be used to easily connect the controller to a PC. Also, the RS485 interface allows the BLY17MDC to connect to PLCs (Programmable Logic Controller) or HMIs (Human Machine Interfaces), where the PLC or HMI gives the BLY17MDC serial commands to control its operation.

The second way to give commands to the BLY17MDC is to use the BMC100 software for manual control. Through the BMC100 software, the user can control motion as well as modifying motor and controller parameters even when the motor is running. Additionally, the software can be used to monitor motor speed at any time.

### Baud Rate

Baud rate is a term frequently used in serial data communications; a "baud" is defined as the reciprocal of the shortest pulse duration in a data word signal, including start, stop, and parity bits. This is often taken to mean the same as "bits per second," a term that expresses only the number of "data" bits per second. Very often, the parity bit is included as an information or data bit. The BLY17MDC Series accepts a baud rate of 38400 only.

# Electrical Specifications

**Power Requirement with No Connections:**  
24VDC @ 50mA

**Operating Temperature:**  
0 to 60 degrees C

**5VDC Max Output Current:**  
25mA

**Run/Stop Max Input Voltage:**  
7VDC

**Analog Input Range:**  
0 - 5VDC

**Communication Interface:**  
Two-wire RS485

**Data Format:**  
Half-Duplex  
1 start bit  
8 data bits  
No parity  
1 Stop bit

**Baud Rate:**  
38400 baud, Fixed

## Ordering Information

The table below lists a variety of products available from Anaheim Automation, Inc. These products include those covered by this manual, along with supporting cables and devices. We are continually adding new products to our line, so please consult Anaheim Automation, Inc. or its representatives for information on the latest releases.

Part Number	Description
BLY17MDC	Featured Programmable Brushless DC Motor Controller
485SD9TB	USB-to-RS485 data converter
PSAM 24V 2.7A	DC Power Supply 24V at 2.7 Amps (60 Watts)
PSAM 24V 5.2A	DC Power Supply 24V at 5.2 Amps (125 Watts)
PSAM 24V 8.3A	DC Power Supply 24V at 8.3 Amps (200 Watts)

# Dimensions

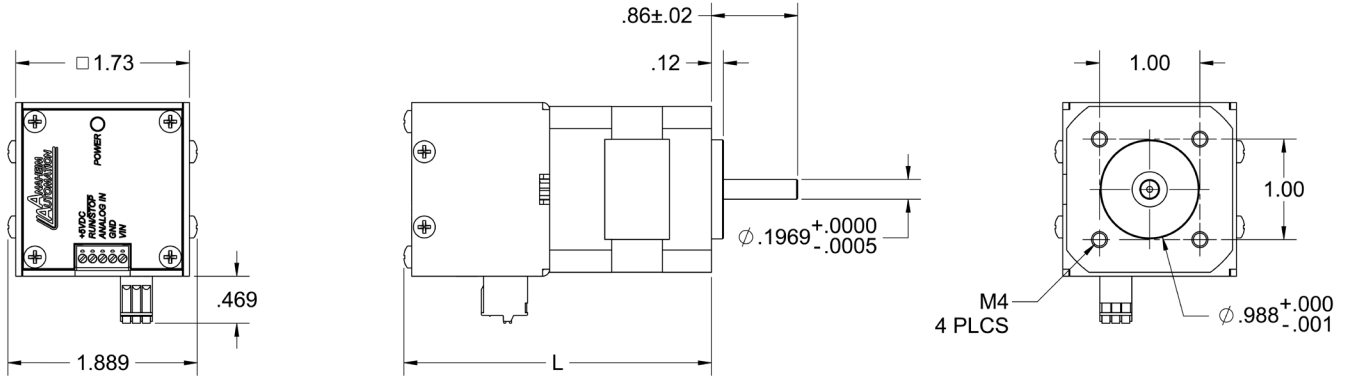

Model	L (in.)	Torque (oz-in)	Power (W)	Current (A)
BLY17MDC1	2.97	27	26	1.8
BLY17MDC2	3.75	54	53	3.5
BLY17MDC3	4.57	79	77	4.9
BLY17MDC4	5.33	106	104	7.0

# Wiring Diagram

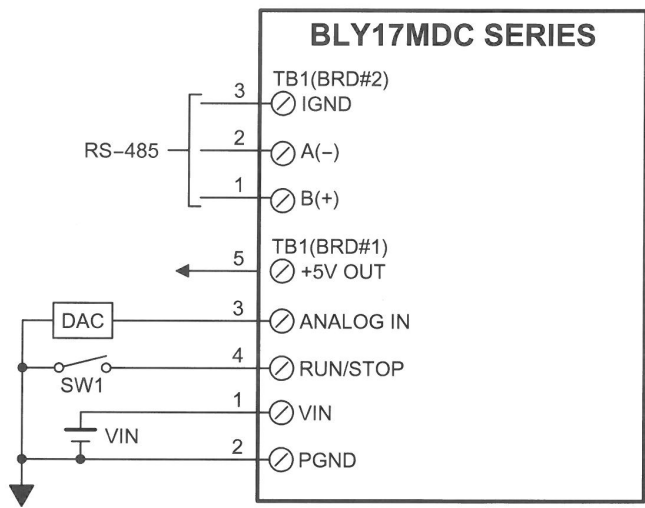

Terminal Description	
Position	Description
1	Power 24VDC IN
2	Power Ground
3	Analog Speed Input
4	RUN/STOP Input
5	5VDC Output
1	RS485 A(-)
2	RS485 B(+)
3	RS485 Isolated Ground

# Torque Curves

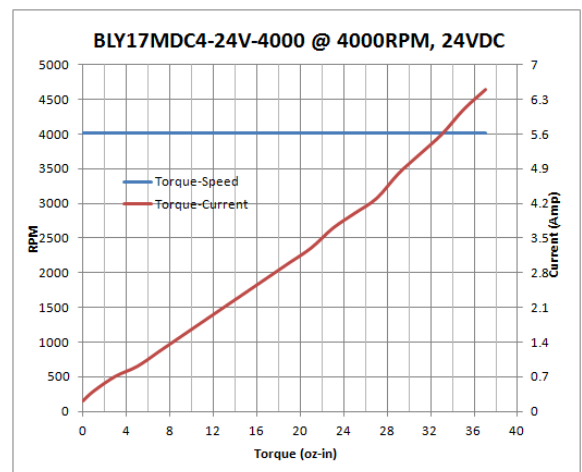
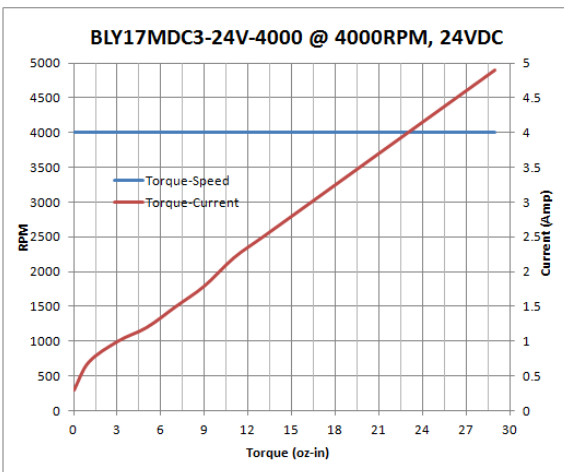
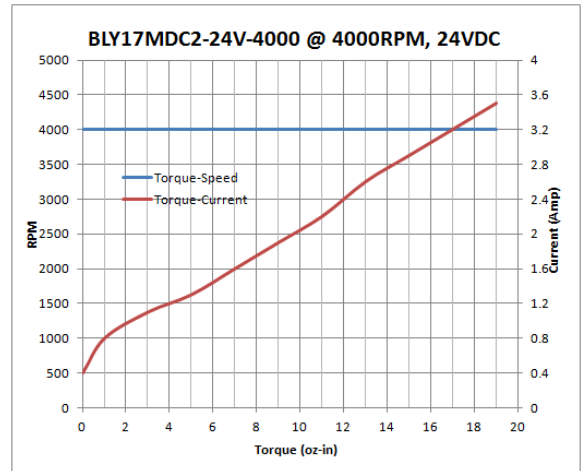
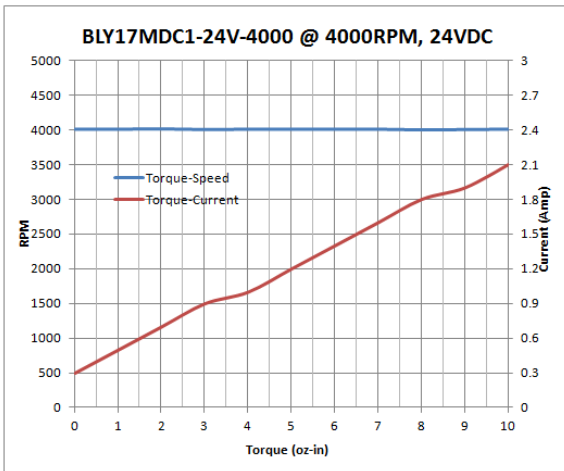

## No Load Acceleration

The table below lists the time it take the motor under no load to get from 0 RPM to 4000 RPM with different gain values. Different Ki, Kp and IV values will also effect this time. This Test was done with the factor default settings for Ki, Kp and IV values.

Gain	Time(seconds)	Gain	Time(seconds)
1	5.48	8	.912
2	3.16	9	.828
3	2.04	10	.748
4	1.66	20	.414
5	1.31	30	.303
6	1.20	40	.277
7	.992	50	.239

## Section 2: Functions

**Run at the Set Speed:** This command starts the motion of the motor in the set direction and at the set speed. The set speed, which can be set either digitally or with an analog input to the controller, is in units of RPM. The motor will run and get up to speed according to the configurable controller parameters. When the set speed is too high for the motor to reach of if the load is more than what the motor can handle, the motor will run at the maximum speed that is possible under such circumstances. The user can give this command to the BLY17MDC by interfacing the controller with a pc and using the provided software or by grounding the RUN/STOP input.

Note: If the motor is started digitally, it must be stopped digitally; similarly, if it is started with the RUN/STOP input, it must be stop through that input.

**Hard Brake:** This command causes the motor to come to an immediate stop. If the motor is moving at fast speed, it will experience jerk. The motor will perform a hard brake when that brake setting has been selected. See also Freewheel/Coast.

**Freewheel/Coast:** This command causes the motor to naturally decelerate and come to stop. Note that the deceleration time will depend on the load attached to the shaft as this will change the shaft's rotational inertia. The motor will perform this function when the respective brake setting has been selected. See also Hard Brake.

**Direction:** The motor can be set to run clockwise or counterclockwise. This setting can be changed through the used of the provided software.

**Analog Speed Input:** This function allows for the speed of the motor to be set with an analog voltage value fed to the the Analog Input terminal pin. This voltage value must be between 0 and 5VDC. Using this analog value, the controller will calculate the set speed based on the user-configurable Analog Lower and Upper Limits. For example, if the Analog Lower Limit is set to 1000 RPM and the Analog Upper Limit is set to 4000 RPM, feeding an analog voltage value of 2.5V will yield a Set Speed of 2500 RPM. Note that the Analog Speed functionality can be easily achieved by using a potentiometer with its end terminals connected to GND and 5VDC Out, and the wiper terminal connected to the Analog Input.

*Analog Speed Calculations:*

$$\text{Speed(RPM)} = \text{Lower Limit} + (\text{Upper Limit} - \text{Lower Limit}) * (\text{Analog Voltage} / 5)$$

$$\text{Analog Voltage(V)} = (\text{Speed} - \text{Lower Limit}) * 5 / (\text{Upper Limit} - \text{Lower Limit})$$

*Example 1:    Analog Lower Limit = 100,    Analog Upper Limit = 2000  
                  Analog Input Voltage = 3.2V*

$$\text{Speed} = 100 + (2000 - 100) * (3.2 / 5) = 1316 \text{ RPM}$$

*Example 2:    Analog Lower Limit = 500,    Analog Upper Limit = 4000  
                  Desired Speed = 3300 RPM*

$$\text{Analog Voltage} = (3300 - 500) * 5 / (4000-500) = 4.0V$$

**RUN/STOP Input:** Grounding this input will cause the motor to start its motion with the set parameters. Driving this input High(5VDC) or making it High Impedance(i.e. no electrical connection), will stop the motor with a Hard Brake or Coast it to a stop depending on the current brake setting. See Hard Brake and Freewheel for more details on the brake setting.

**Set Address:** This command allows the user to set the address of the device to any value between 0 and 99. This is useful when communicating with different devices connected to the same RS485 bus. The default address of the device is 0.

**Read Address:** This command retrieves the current address of the device. See command summary for more details.

**Read Error:** This command returns the errors, if any, that the controller has encountered. Reading the error also clears it. See the Error Code Section for more details.

## PI Control Tuning

The BLY17MDC implements a custom Proportional and Integral speed control algorithm with user configurable parameters. The user can customize the control parameters via the provided software or by using Direct Talk Mode.

The following chart describes the effects of an increase in each of the parameters. It follows that a decrease in the specified parameter would have the opposite effect.

Parameter Increase	Rise Time	Overshoot	Settling Time	Steady State Error
<b>Ki [0-10]</b>	↑	↓	↑	↓
<b>Kp [0-100]</b>	↑	↑	↑	No effect
<b>IV [0-100]</b>	↑	↑	↑	No effect

**Integrator Constant [Ki]:** The integrating component of the control algorithm accumulates the error between the set speed and the actual speed of the motor and adjusts the speed control accordingly. This component of the control system is important because it helps reduce the long term error of the motor speed.

**Proportional Constant [Kp]:** The proportional component of the control algorithm adjusts the speed control based on the immediate difference between the set speed and the actual speed. This component is important because its increase reduces the time it takes for the motor to reach the set speed. Note that increasing this constant will cause the overshoot in speed to increase.

**Initial Value [IV]:** This is the initial power applied to the motor in order to get its load in motion. If the load requires a higher torque to begin its motion, a higher Initial Value can be set. Note that if the load is very small and the Initial Value is high, the motor may experience jerk. In order to find what value you need take  $IV \cdot 4 / 1023$  and this is the percentage of power applied to the phases upon receiving a start command.



## Section 3: BMC100 Software

The BCM100 software is a useful utility that supports Anaheim Automation's BLY17MDC Series and MDC100-050101USB controllers. The BMC100 software communicates via a serial port on the PC and it uses the Anaheim Automation ASCII protocol. For more details regarding the Anaheim Automation ASCII protocol, see the Direct Talk Mode section. The BMC100 software allows you to perform the following tasks:

- Exercise the motor
- Monitor the speed of the motor
- Configure motor and control parameters

### Installation

#### Software Download

- The BMC100 software is available for download on our website at <https://www.anaheimautomation.com/downloads/software/software.php>
- The software is compatible with all versions of Windows including Windows XP, Windows Vista, Windows 7, and Windows 8.

#### Windows XP/Vista/7/8 Installation

1. Extract the previously downloaded .zip file containing the software
2. Navigate into the resulting extracted folder
3. Double click on the file named setup.exe
4. Follow the prompts to complete the installation

### Getting Started

1. In order to interface the BLY17MDC to a PC, an RS485-to-USB converter is required. See our Ordering Information section.
2. Connect the BLY17MDC to the PC using the previously mentioned RS485-toUSB converter.
3. Apply power to the BLY17MDC. The power LED should turn on if the controller has powered correctly.
4. Double click on the BMC100 software icon.
5. Select the controller; in this case, select BLY17MDC.

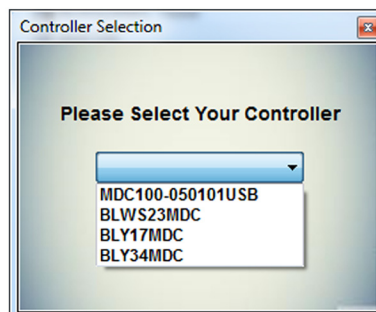

- The BMC100 software will attempt to establish communications with the controller; if a connection is established, the BMC100 graphical interface will appear as shown below.

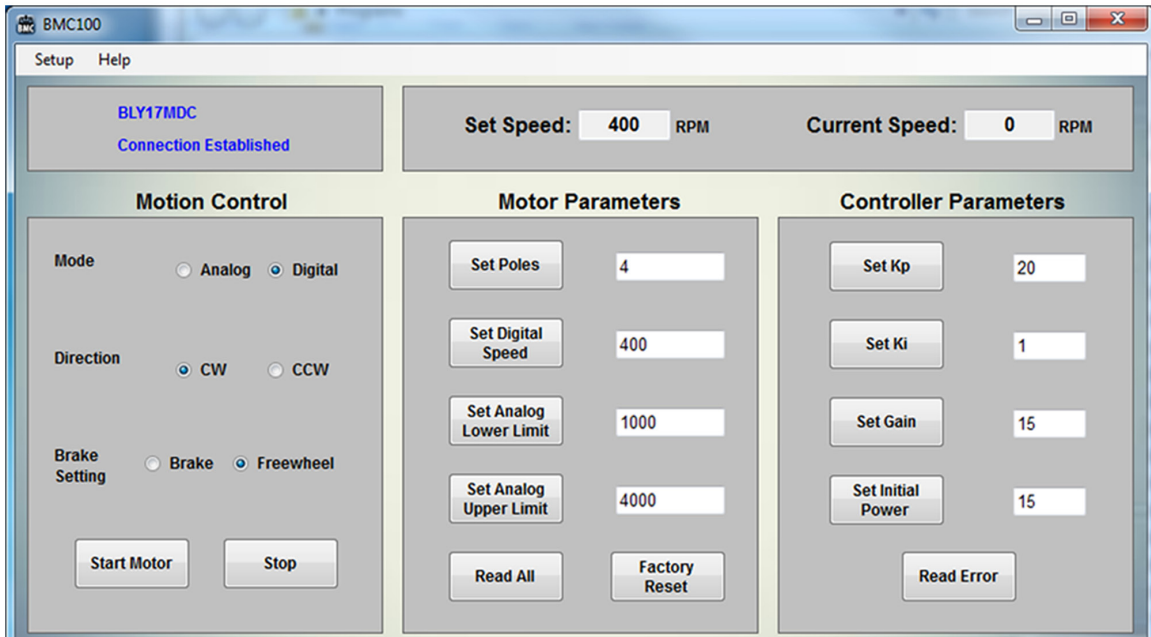

- If the software did not automatically establish a connection with the controller, make sure that the controller is properly connected to the PC using an RS485-to-USB adapter and that the controller is powered on. Then, manually connect the controller by clicking on **Setup>Connect**. The Connect window will appear as shown below. Select the appropriate COM port from the dropdown menu and click on **Connect Controller**.

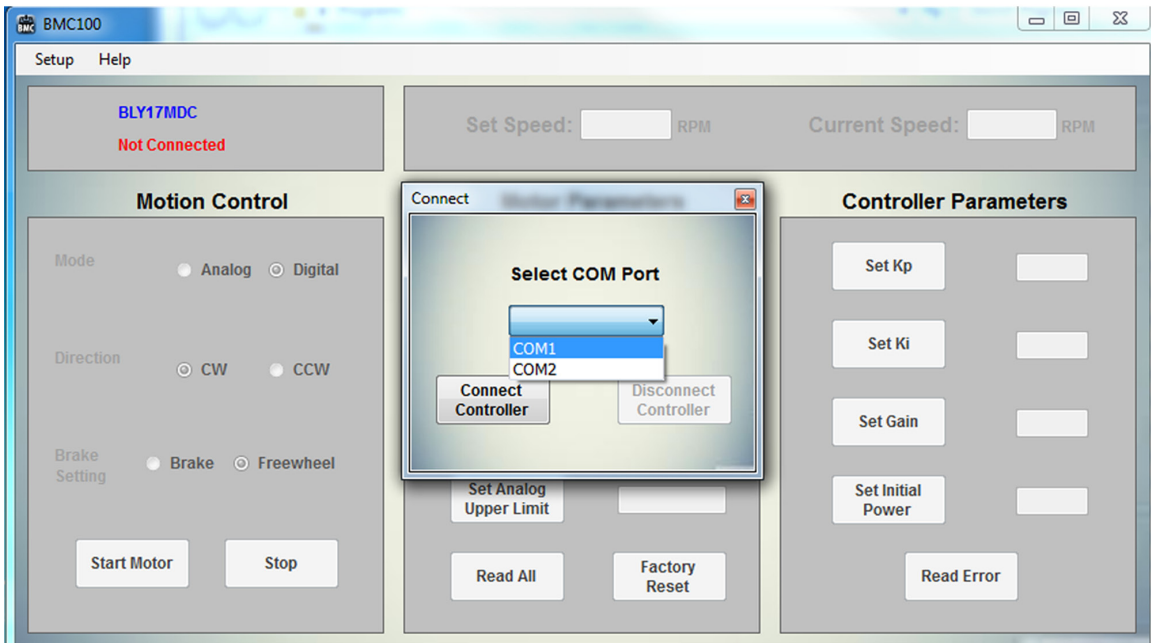

- Once the connection is successfully made, all the buttons on the graphical interface will be enabled and the default(if the controller is new) or previously programmed parameters will fill the respective fields.

## Motion Control

<b>Mode</b>	Sets the controller to run in Analog or Digital Mode
<b>Direction</b>	Sets the direction of rotation of the motor to Clockwise or Counter-Clockwise
<b>Freewheel</b>	If this is set, the motor will coast to a stop when the stop command is received
<b>Brake</b>	If this is set, the motor will immediately stop when the stop command is received
<b>Start Motor</b>	Runs the motor at the set speed
<b>Stop</b>	Immediately stops the motor or lets it coast to a stop depending on the brake setting

## Motor Parameters

<b>Set Poles</b>	This parameter is not configurable in the BLY17MDC
<b>Set Digital Speed</b>	Sets the speed to run the motor at in Digital Mode
<b>Set Analog Lower Limit</b>	Sets the Lower Speed Limit for Analog Mode
<b>Set Analog Upper Limit</b>	Sets the Upper Speed Limit for Analog Mode
<b>Read All</b>	Refreshes all the parameters fields of the graphical interface
<b>Factory Reset</b>	Sets all the parameter of factory default values

See the **Functions** Section for more details.

## Controller Parameters

<b>Set Kp</b>	Sets the Proportional Constant
<b>Set Ki</b>	Sets the Integrator Constant
<b>Set Gain</b>	Sets the Gain Constant
<b>Set Initial Power</b>	Sets the Initial Power to be applied to the motor
<b>Read Error</b>	Reads the error registers of the controller

For more details on fine tuning the controller for your application, see the **PI Tuning** Section.

## Section 4: Direct Talk Mode

Direct Talk Mode is used to directly control the BLY17MDC through serial commands sent out of a PC's COM port. The BLY17MDC has easy-to-remember commands for direct motion control.

COM Port Settings	
Baud Rate	38400
Data Bits	8
Parity	None
Stop Bits	1
Flow Control	Xon/Xoff

### Command Format

Start	Address	Command	Parameters <sup>(1)</sup>	End
'@' character	1 - 2 characters	1 - 2 characters	0 - 8 characters	Carriage Return

The command does not need to be sent as a continuous string; this allows user to use a simple terminal program to communicate and control the device via a serial connection. The command must not contain any spaces.

(1) Not all commands require parameters. See Command Summary for details.

### Unit Selection

In an RS485 network, multiple devices may share the same communication lines; therefore, it is important to be able to address the messages or commands sent through these lines to the device that we want. In order to communicate with a BLY17MDC unit, the '@' character must be followed by the address of the unit as shown in the Command Format above.

Examples:

- @0 (Unit with address 0 is selected)
- @1 (Unit with address 1 is selected)
- @29 (Unit with address 29 is selected)

Note: The '#' character can be used in place of the address to select any or all units.

### Command Summary

<b>A</b>	Analog Mode
<b>D</b>	Digital Mode
<b>F</b>	Set to Factory Default
<b>IV</b>	Set Initial Value
<b>KG</b>	Set Gain Value
<b>KI</b>	Set Integrator Constant
<b>KP</b>	Set Proportional Constant
<b>M</b>	Set Digital Speed
<b>S</b>	Start Motor
<b>VD</b>	Verify Direction
<b>VDS</b>	Verify Digital Speed

<b>VIV</b>	Verify Initial Value
<b>VKG</b>	Verify Gain Value
<b>VKI</b>	Verify Integrator Constant
<b>VKP</b>	Verify Proportional Constant
<b>VM</b>	Verify Current Speed
<b>VMO</b>	Verify Mode
<b>VN</b>	Verify Analog Speed Min
<b>VX</b>	Verify Analog Speed Max
<b>VP</b>	Verify Number of Poles
<b>VS</b>	Verify Set Speed

<b>VST</b>	Verify Brake Setting
<b>V*</b>	Verify All Parameters
,	Coast/Freewheel
.	Hard Brake
+	Set Clockwise Direction
-	Set Counterclockwise Direction
%	Verify address
~	Set address
[	Set Analog Speed Min
]	Set Analog Speed Max

## **A Analog Mode**

Format: A

Description: Engages the Analog Mode; in this mode, the speed is set from the analog input value according to the analog upper and lower limits.

## **D Digital Mode**

Format: D

Description: Engages the Digital Mode; in this mode, the speed is set digitally through the provided software or using an RS-485 capable machine controller.

## **F Digital Mode**

Format: F

Description: This command restores all the parameters and variables to default.

## **IV Initial Value**

Format: IV[value]

Description: Sets the Initial Value parameter of the controller.

Range: 0 - 100

## **KG Gain Value**

Format: KG[value]

Description: Sets the Gain Constant value of the PI control algorithm.

Range: 0 - 50

## **KI Integrator Constant**

Format: KI[value]

Description: Sets the Integrator Constant value of the PI control algorithm.

Range: 0 - 10

**KP Proportional Constant**

Format: KP[value]

Description: Sets the Proportional Constant value of the PI algorithm.

Range: 0 - 100

**M Digital Speed**

Format: M[value]

Description: Sets the Digital Speed of the device. Note that the controller must be in Digital Mode in order to run the motor at the set Digital Speed. If the controller is in Analog Mode, the Digital Speed will be changed, but the motor will keep running at the Analog Speed.

Range: 100 - 4000

**S Start Motor**

Format: S

Description: Runs the motor at the motor at the set speed through the PI algorithm. The set speed will depend on whether the controller is in Analog or Digital Mode.

**VD Verify Direction**

Format: VD

Description: Returns the currently set direction of the motor.

**VDS Verify Digital Speed**

Format: VDS

Description: Returns the Set Point Speed of the Digital Mode.

**VIV Verify Initial value**

Format: VIV

Description: Returns the current Initial Value for the power applied to the motor.

**VKG Verify Gain Value**

Format: VKG

Description: Returns the currently set Gain Constant value.

**VKI Verify Integrator Constant**

Format: VKI

Description: Returns the currently set Integrator Constant value.

**VKP Verify Proportional Constant**

Format: VKP

Description: Returns the currently set Propotional Constant value.

**VM Verify Current Speed**

Format: VM

Description: Returns the actual speed that the motor is currently running at.

**VMO Verify Mode**

Format: VMO

Description: Returns the mode that the controller is currently operating in. If the controller is in Analog Mode, this command return 'MOA'; if in Digatl Mode, it will return 'MOD'.

**VN Verify Analog Speed Min**

Format: VN

Description: Returns the currently set lower boundary of the Analog Speed Mode.

## **VX Verify Analog Speed Max**

Format: VX

Description: Returns the currently set upper boundary of the Analog Speed Mode.

## **VP Verify Number of Poles**

Format: VP

Description: Returns the currently set Gain Constant value.

## **VS Verify Set Speed**

Format: VS

Description: Returns the value of the currently set speed in RPM. If the controller is operating in Digital Mode, it returns the value of the Digital Speed; else, it returns the Analog Speed Value.

## **VST Verify Brake Setting**

Format: VST

Description: Returns the current brake setting. If the currently selected brake setting is “Hard Brake”, the controller will return “ST.”; if “Freewheel” is currently selected, the controller will return “ST,”.

## **V\* Verify All Parameters**

Format: V\*

Description: Returns all the programmable verifiable parameters of the BLWS23MMDC. An example of this command can be seen in the picture below.

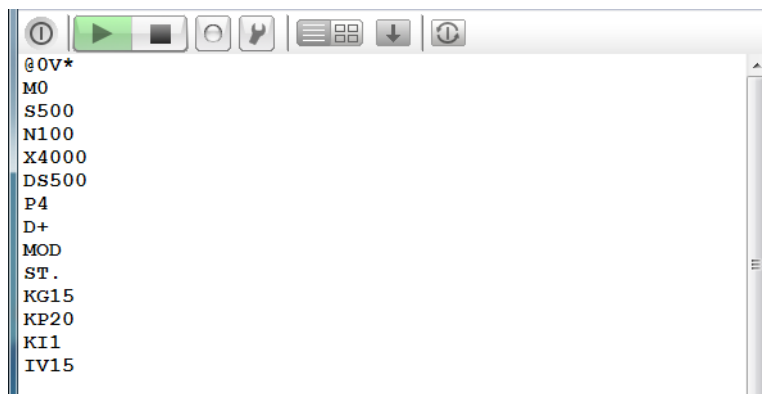

```
@0V*
M0
S500
N100
X4000
DS500
P4
D+
MOD
ST.
KG15
KP20
KI1
IV15
```



, **Coast/Freewheel**

Format: ,

Description: This command causes the motor to coast to a stop if in motion, and changes the brake setting to “Freewheel”.

. **Hard Brake**

Format: .

Description: This command causes the motor to immediately stop if in motion, and it changes the brake setting to “Hard Brake”.

+ **Clockwise Direction**

Format: +

Description: Sets the direction of the motor to clockwise. If this command is sent to the controller while the motor is in motion and spinning counterclockwise, the motor will brake and reverse direction.

- **Counterclockwise Direction**

Format: -

Description: Sets the direction of the motor to counterclockwise. If this command is sent to the controller while the motor is in motion and spinning clockwise, the motor will brake and reverse direction.

% **Verify Address**

Format: %

Description: Returns the current address of the controller.

~ **Set Address**

Format: ~[new address]

Description: Sets the device address of the controller.

Range: 0 - 99

[ **Set Analog Speed Min**

Format:        [[value]

Description:   Sets the lower boundary of the Analog Speed Mode to the given value. The value must be in RPM. The Analog Speed Min must be less than the Analog Speed Max.

Range:         100 - 4000

] **Set Analog Speed Max**

Format:        ][value]

Description:   Sets the upper boundary of the Analog Speed Mode to the given value. The value must be in RPM. The Analog Speed Max must be greater than the Analog Speed Min.

Range:         100 - 4000

## Section 5: Troubleshooting

### Problem:

Cannot establish communications between the BLY17MDC and my PC.

### Possible Solutions:

- 1) Make sure that the controller has power. Is the green LED on?
- 2) Make sure you are using the required RS485-to-USB converter.
- 3) Check for loose connections on the terminal block of the controller.
- 4) Was the software installed correctly? Reinstall if it wasn't.
- 5) Is the device being detected as a COM port? This can be checked by going into your PC's **Device Manager** and clicking on **Ports**; if the device has been recognized, you should see a port labeled **USB Serial Port**. If this doesn't appear under ports, install the drivers for your RS485-to-USB converter.
- 6) If problems still exist, contact Anaheim Automation Tech Support.

Anaheim Automation, Inc.  
Tech Support:

4985 E Landon Drive  
Anaheim, CA 92807  
Phone: (714) 992-6990  
Fax: (714) 992-0471  
[www.anaheimautomation.com](http://www.anaheimautomation.com)

### Problem:

There is no power to the BLY17MDC controller.

### Possible Solutions:

- 1) Is the BLY17MDC controller connected to the appropriate power supply?
- 2) Check for any blown fuses in line with the BLY17MDC controller.
- 3) If problems still exist, contact Anaheim Automation, Inc. Tech Support.

## Error Codes

Error Code	Type	Description
1	Command Error	An invalid command was sent to the BLY17MDC.
2	Range Error	An invalid number of characters were sent to the controller.
4	Busy Error	The command sent to the controller cannot be executed while the motor is running.
8	Poles Error	The number of poles sent to the controller is invalid.
16	Kp Error	The Proportional Constant value sent to the controller is out of range.
32	Ki Error	The Integrator Constant value sent to the controller is out of range.
64	Gain Error	The gain constant value sent to the controller is out of range.
128	Speed Range Error	The Upper Analog Speed Limit must be greater than the Lower Analog Speed Limit. The lower limit must be greater than or equal to 100 RPM
256	Initial Value Error	The Initial Value sent to the controller is out of range.

## Appendix 1: ASCII Table for Direct Mode

ASCII Symbol	Hex Value	ASCII Symbol	Hex Value	ASCII Symbol	Hex Value
0	30	J	4A	#	23
1	31	K	4B	\$	24
2	32	L	4C	%	25
3	33	M	4D	"	27
4	34	N	4E	(	28
5	35	O	4F	+	2B
6	36	P	50	,	2C
7	37	Q	51	-	2D
8	38	R	52	.	2E
9	39	S	53	:	3A
A	41	T	54	;	3B
B	42	U	55	@	40
C	43	V	56	[	5B
D	44	W	57	]	5D
E	45	X	58	^	5E
F	46	Y	59	{	7B
G	47	Z	5A	}	7D
H	48	Carriage Return	0D	~	7E
I	49	!	21		

## Appendix 2: Firmware Revisions

Version 1.00 - Initial Release.

## **COPYRIGHT**

Copyright 2017 by Anaheim Automation. All rights reserved. No part of this publication may be reproduced, transmitted, transcribed, stored in a retrieval system, or translated into any language, in any form or by any means, electronic, mechanical, magnetic, optical, chemical, manual, or otherwise, without the prior written permission of Anaheim Automation, 4985 E Landon Drive, Anaheim, CA 92807.

## **DISCLAIMER**

Though every effort has been made to supply complete and accurate information in this manual, the contents are subject to change without notice or obligation to inform the buyer. **In no event will Anaheim Automation be liable for direct, indirect, special, incidental, or consequential damages arising out of the use or inability to use the product or documentation.**

Anaheim Automation's general policy does not recommend the use of its' products in life support applications wherein a failure or malfunction of the product may directly threaten life or injury. Per Anaheim Automation's Terms and Conditions, the user of Anaheim Automation products in life support applications assumes all risks of such use and indemnifies Anaheim Automation against all damages.

## **LIMITED WARRANTY**

All Anaheim Automation products are warranted against defects in workmanship, materials and construction, when used under Normal Operating Conditions and when used in accordance with specifications. This warranty shall be in effect for a period of twelve months from the date of purchase or eighteen months from the date of manufacture, whichever comes first. **Warranty provisions may be voided if products are subjected to physical modifications, damage, abuse, or misuse.**

Anaheim Automation will repair or replace at its' option, any product which has been found to be defective and is within the warranty period, provided that the item is shipped freight prepaid, with previous authorization (RMA#) to Anaheim Automation's plant in Anaheim, California.

## **TECHNICAL SUPPORT**

If you should require technical support or if you have problems using any of the equipment covered by this manual, please read the manual completely to see if it will answer the questions you have. If you need assistance beyond what this manual can provide, contact your Local Distributor where you purchased the unit, or contact the factory direct.

**ANAHEIM AUTOMATION**