

TBI Ball Screw Support Units

FK Series



FEATURES

- Fixed-Side Rectangular Type
- Ball Screw Diameter: 10mm to 40mm
- Input Shaft Diameter: 8mm to 30mm
- Allowable Axial Load: Up to 939Kgf
- Allowable Static Load: Up to 1388Kgf
- Maximum Speed: Up to 16,800RPM
- Applicable Screw Accuracy: C3, C5, or C7
- Low Profile Design
- Black Oxide Surface Treatment



DESCRIPTION

The Round-Type FK Fixed-Side Support Unit Series are available to fit input shaft diameters ranging from 8mm to 30mm. These support units are compact in size and allow for easy installation. All support units come with angular contact bearings which are assembled with the correct preload and amount of lubrication. These support units have an allowable axial load up to 939Kgf, allow static load up to 1,353Kgf, and can handle speeds up to 28,000RPM (model dependent).

Item	d1	L	H	F	E	Dg6	A	PCD	B	L1	T1	X	Y	Z
TBI-BSC-SU-FK8	8	23	9	14	26	28	43	35	35	7	4	3.4	6.5	4
TBI-BSC-SU-FK10	10	27	10	17	29.5	34	52	42	42	7.5	5	4.5	8	4
TBI-BSC-SU-FK12	12	27	10	17	29.5	36	54	44	44	7.5	5	4.5	8	4
TBI-BSC-SU-FK15	15	32	15	17	36	40	63	50	52	10	6	5.5	9.5	6
TBI-BSC-SU-FK20	20	52	22	30	50	57	85	70	68	8	10	6.6	11	10
TBI-BSC-SU-FK25	25	57	27	30	60	63	98	80	79	13	10	9	15	13
TBI-BSC-SU-FK30	30	62	30	32	61	75	117	95	93	11	12	11	17.5	15

UNITS: mm

DIMENSIONS

4-X drill through
øY counter bore depthZ

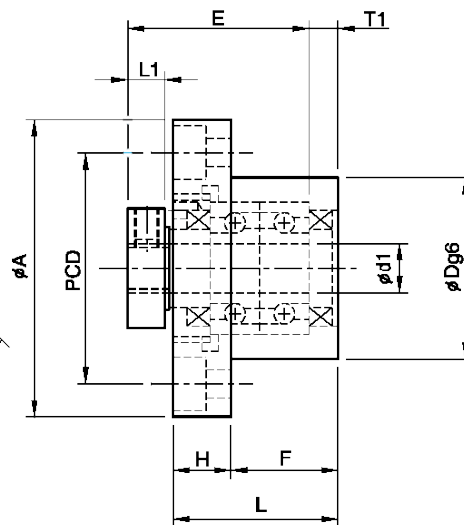
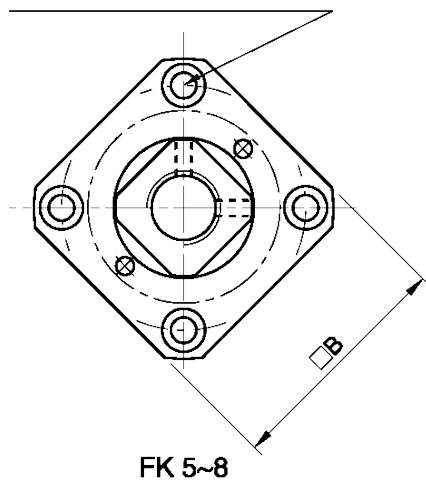

4-X drill through
øY counter bore depthZ

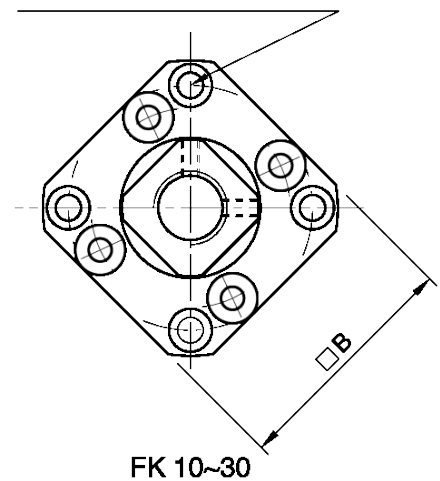

L011176

Item	Ball Screw Diameter	Input Shaft Diameter				Metric Screw Thread	
	d	A	B	E	F	M	S
TBI-BSC-SU-FK8	10, 12	8	6	32	9	M8X1	10
TBI-BSC-SU-FK10	12, 14, 15	10	8	36	15	M10X1	11
TBI-BSC-SU-FK12	14, 15, 16	12	10	36	15	M12X1	11
TBI-BSC-SU-FK15	18, 20	15	12	47	20	M15X1	13
TBI-BSC-SU-FK20	25, 28, 30	20	17	62	25	M20X1	17
TBI-BSC-SU-FK25	30, 32, 36	25	20	76	30	M25X1.5	20
TBI-BSC-SU-FK30	36, 40	30	25	72	38	M30X1.5	25

