

# NSK Grease Unit

The NSK Grease Unit is a compact and easy-to-use lubrication unit for use on the NSK Linear Guides™, ball screws and Monocarriers™. We provide a wide variety of grease to choose from to meet your needs.



# NSK Grease Unit

For lubrication of the guiding and feeding parts of the NSK Linear Guides™, ball screws and Monocarriers™

Appropriate lubrication of guiding and feeding parts is essential to maximizing the efficiency and usefulness of machinery from engineering tools to semiconductor equipment. NSK provides various types of grease units that you can choose from for use in high-speed, high-load, oscillating, and high-temperature environments or clean rooms.

## Features of NSK Grease Unit

NSK provides compact, hand-operated grease pumps and a wide variety of nozzles that enable you to easily apply grease to guiding and feeding parts. You can easily attach a bellows tube container to the pump. The name of the grease being used is on the bottom of the bellows tube container. Containers are color-coded to make it easier to identify the type of grease after the container is attached to the pump.

## Configurations of NSK Grease Unit

### NSK Grease

General High-load



NSK Grease AS2  
(NSK GRS AS2) [Page 3](#)

Clean



NSK Grease LG2  
(NSK GRS LG2) [Page 5](#)

Low-temperature Light-load



NSK Grease PS2  
(NSK GRS PS2) [Page 7](#)

Oscillation



NSK Grease NF2  
(NSK GRS NF2) [Page 8](#)

High-speed



NSK Grease LR3  
(NSK GRS LR3) [Page 4](#)

Clean High-temperature



NSK Grease LGU  
(NSK GRS LGU) [Page 6](#)

Low-temperature



NSK Grease NS7  
(NSK GRS NS7) [Page 9](#)

Oscillation High-speed



NSK Grease NSL  
(NSK GRS NSL) [Page 9](#)

### NSK Hand Grease Pump Unit



NSK Hand Grease Pump (A straight nozzle is provided with a hand grease pump.)  
(NSK HGP) [Page 11](#)



#### Grease Nozzle (sold separately with grease pump)

- NSK straight nozzle
- NSK chuck nozzle
- NSK fitting nozzle
- NSK point nozzle
- NSK flexible nozzle
- NSK flexible extension pipe
- NSK straight extension pipe
- NSK MCH exclusive fitting nozzle

[Page 12](#)

## NSK Grease AS2

Reference no. : NSK GRS AS2  
Quantity: 80 g Tube color: Brown



## NSK Grease LR3

Reference No. : NSK GRS LR3  
Quantity: 80 g Tube color: Green



### Feature

It is an environmentally friendly and widely used grease for high load application. It is mineral oil based grease containing lithium thickener and several additives. It is superb in load resistance as well as stability in oxidization. It not only maintains good lubrication over a long period of time, but also demonstrates superb capability in retaining water. Even containing a large amount of water, it does not lose grease when it is softened.

### Application

It is a standard grease for general NSK linear guides, ball screws and monocarriers. It is prevalently used in many applications because of its high base oil viscosity, high load resistance, and stability in oxidization.

### Range of use temperature

-10 to +110°C

### Properties

Thickener	Lithium soap base
Base oil	Mineral oil
Consistency	275
Dropping point	181°C
Volume of evaporation	0.24% (99°C, 22 hr)
Copper plate corrosion test	Satisfactory (Method B, 100°C, 24 hr)
Oil separation	2.8% (100°C, 24 hr)
Base oil kinematic viscosity	130 mm <sup>2</sup> /s (40°C)

### Maintains good lubrication over a long period of time

#### ▶ Sample: Ball Screw

Shaft diameter	36 mm
Lead	10 mm
Dynamic load rating	27 200 N

#### ▶ Test conditions

Load	7 300 N
Rotational speed	1 000 min <sup>-1</sup>
Stroke	60 mm
Intervals of replenishments	Periodically

#### ▶ Result of durability test (example)

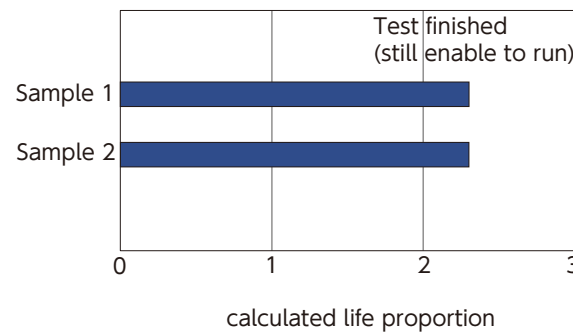

#### ▶ Comparison of ball screw track surfaces

##### Before running

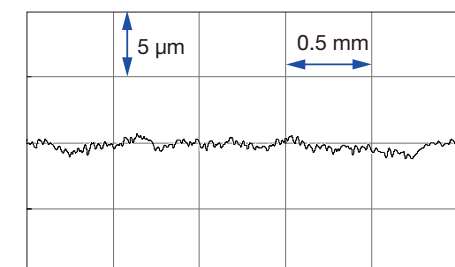

##### After running

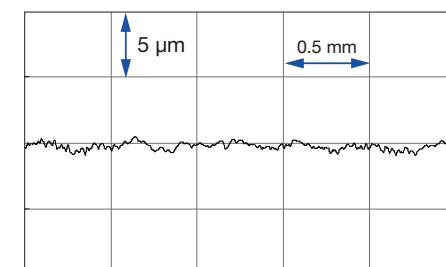

### Feature

It contains a special synthetic oil for high temperature and stability, and a carefully selected anti-oxidation agent. This grease dramatically increases lubrication life under high temperature conditions. It is used for high speed, medium load. Lubrication life exceeded 2 000 hours in the endurance test at 150°C. Its rust prevention capacity in severe conditions such as water and moist environments is further strengthened.

### Application

It is a standard grease for ball screws PSS type (shaft dia. 15 mm or over), FSS type and VFA type. It is ideal for operation with medium load, at high speed such as positioning in high tact material handling equipment.

### Range of use temperature

-30 to +130°C

### Properties

Thickener	Lithium soap base
Base oil	Synthetic oil
Consistency	227
Dropping point	208°C
Volume of evaporation	0.30% (99°C, 22 hr)
Copper plate corrosion test	Satisfactory (Method B, 100°C, 24 hr)
Oil separation	1.9% (100°C, 24 hr)
Base oil kinematic viscosity	30 mm <sup>2</sup> /s (40°C)

### Suitable for high-speed operation

#### ▶ Sample: Ball screw

Shaft diameter	32 mm
Lead	5 mm

#### ▶ Test conditions

Stroke	300 mm
Rotational speed	10 to 1 000 min <sup>-1</sup>

#### ▶ Torque characteristics of ball screw

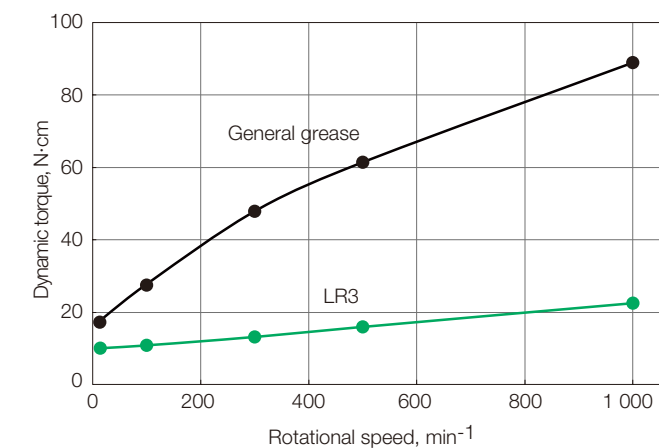



## NSK Grease LG2

Reference no. : NSK GRS LG2  
Quantity: 80 g Tube color: Blue



### Feature

This grease was developed by NSK to be exclusively used for linear guides, ball screws and Monocarriers in clean room. Compared to the fluorine grease which are commonly used in clean room, LG2 has several advantages such as; higher in lubrication function, longer lubrication life, more stable torque (resistant to wear) and higher rust prevention. In dust generation, LG2 is more than equal to fluorine grease in keeping dust volume low. Since the base oil is not a special oil but a mineral oil, LG2 can be handled in the same manner as general greases.

### Application

LG2 is a lubrication grease for rolling element products such as linear guides, ball screws and monocarriers for semiconductor and liquid crystal display (LCD) processing equipment which require a highly clean environment.

It is a standard grease for NSK standard ball screw USS type.

\* Wash the linear guides and ball screws to remove oil prior to applying Clean Grease LG2, so the grease functions are fully utilized.

\* Clean grease is exclusively used for clean environments under normal pressure.

### Range of use temperature

-20 to +70°C

### Properties

Thickener	Lithium soap base
Base oil	Mineral oil + synthetic hydrocarbon oil
Consistency	207
Dropping point	200°C
Volume of evaporation	1.40% (99°C, 22 hr)
Copper plate corrosion test	Satisfactory (Method B, 100°C, 24 hr)
Oil separation	0.8% (100°C, 24 hr)
Base oil kinematic viscosity	30 mm <sup>2</sup> /s (40°C)

### Low-dust emission, low friction, low torque

#### Sample: Linear Guide

#### Test condition

Stroke	1 500 mm
Feed speed	0.1 to 3 m/s

#### Dust emission from linear guide

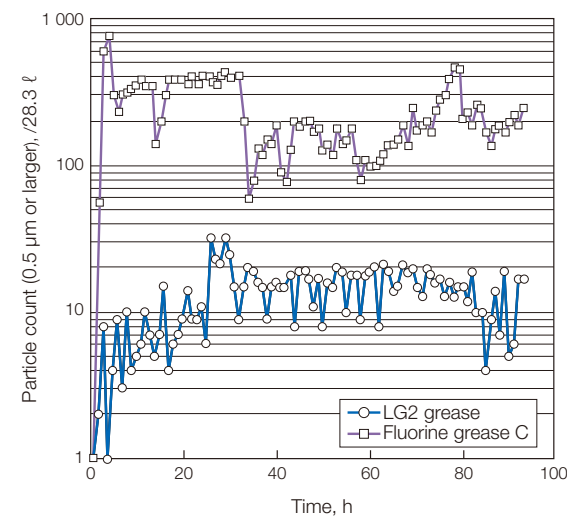

#### Measurement result of linear guide friction force

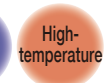
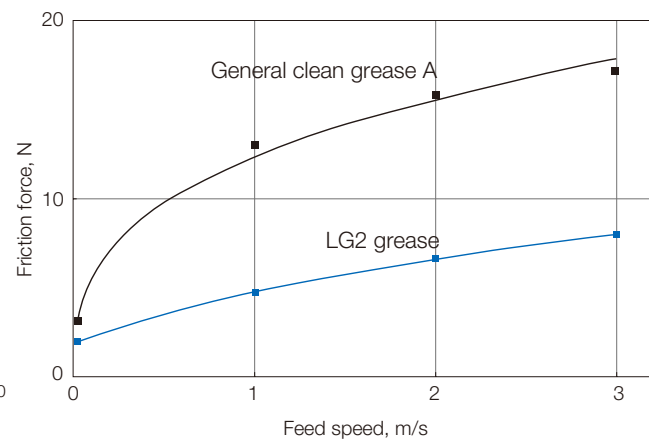

## NSK Grease LGU

Reference no. : NSK GRS LGU  
Quantity: 80 g Tube color: Yellow



### Feature

This is a proprietary urea grease of NSK featuring low dust emission exclusively for ball screws and linear guides which are used in clean rooms.

In comparison with fluorine base grease, which has been used commonly in clean rooms, LGU has better lubricating property, longer duration of lubricant, better torque variation, much better anti-rust property, and equivalent or better dust emission. In addition, this grease can be handled in the same way as the other common grease because high-grade synthetic oil is used as the base oil.

LGU grease contains much less metallic elements compared to LG2 grease. It can be used in high temperature environment.

### Application

This is exclusive lubrication grease for ball screws and linear guides that are installed in equipment that requires cleanliness, as same as LG2 grease, and it can be used in high temperature range.

\* Wash the linear guide and ball screws to remove oil prior to applying Clean Grease LGU, so the grease functions are fully utilized.

\* Clean grease is exclusively used for clean environments under normal pressure.

### Range of use temperature

-30 to +120°C

### Properties

Thickener	Diurea
Base oil	Synthetic hydrocarbon oil
Consistency	209
Dropping point	260°C
Volume of evaporation	0.09% (99°C, 22 hr)
Copper plate corrosion test	Satisfactory (Method B, 100°C, 24 hr)
Oil separation	0.6% (100°C, 24 hr)
Base oil kinematic viscosity	100 mm <sup>2</sup> /s (40°C)

### Superb low torque, low friction as well as LG2

#### Sample: Ball screw

#### Test condition

Shaft diameter	20 mm
Lead	10 mm

Stroke	700 mm
--------	--------

#### Torque characteristics of ball screw

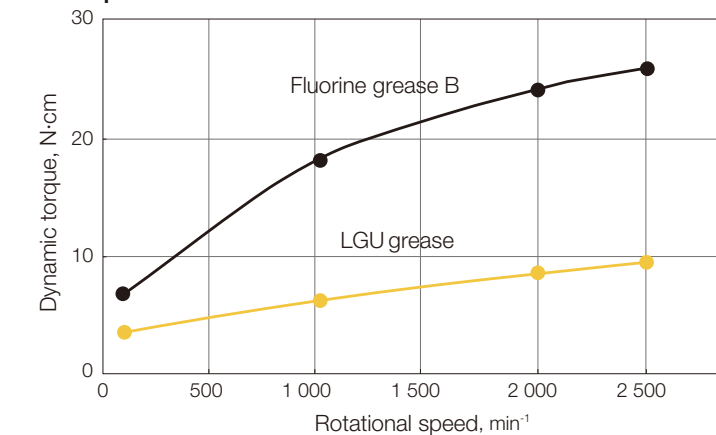

# NSK Grease

Low-temperature  
Light-load

Oscillation

## NSK Grease PS2

Reference no. : NSK GRS PS2  
Quantity: 80 g Tube color: Orange



## NSK Grease NF2

Reference no. : NSK GRS NF2  
Quantity: 80 g Tube color: Gray



### Feature

The major base oil component is synthetic oil with mineral oil. It is an excellent lubrication especially for low temperature operation. It is for high speed and light load.

### Application

It is a standard grease for NSK miniature linear guides and ball screws. It is especially superb for low temperature operation, but also functions well in normal temperatures, making it ideal for small equipment with light load.

### Range of use temperature

-50 to +110°C

### Properties

Thickener	Lithium soap base
Base oil	Synthetic oil + mineral oil
Consistency	275
Dropping point	190°C
Volume of evaporation	0.60% (99°C, 22 hr)
Copper plate corrosion test	Satisfactory (Method B, 100°C, 24 hr)
Oil separation	3.6% (100°C, 24 hr)
Base oil kinematic viscosity	15 mm <sup>2</sup> /s (40°C)

### Good operability in low-temperature conditions

#### ▶ Sample: Ball screw

Shaft diameter	16 mm
Lead	5 mm

#### ▶ Test condition

Rotational speed	100 min <sup>-1</sup>
Stroke	120 mm
Temperature	-32 to +24°C

#### ▶ Torque characteristics of ball screw

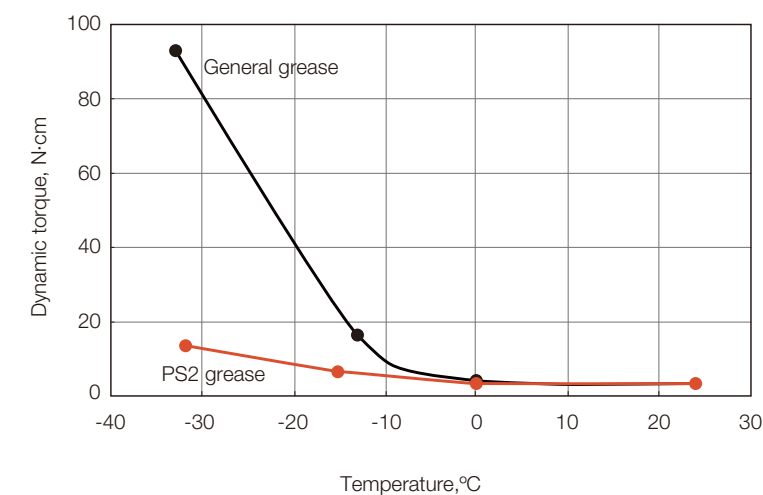

### Feature

It uses high-grade synthetic oil as the base oil and urea base organic compound as the thickener. It has remarkable anti-fretting corrosion property. It can be used in wide temperature range, from low to high, and has superior lubrication life.

### Application

This grease is suitable for ball screws and linear guides of which application include oscillating operations.

### Range of use temperature

-40 to +100°C

### Properties

Thickener	Diurea
Base oil	Synthetic hydrocarbon oil
Consistency	288
Dropping point	269°C
Volume of evaporation	7.9% (177°C, 22 hr)
Copper plate corrosion test	Satisfactory (Method B, 100°C, 24 hr)
Oil separation	0.6% (100°C, 24 hr)
Base oil kinematic viscosity	27 mm <sup>2</sup> /s (40°C)

### Suitable for oscillating operation

#### ▶ Sample: Linear Guide

Model No.	LH25
-----------	------

#### ▶ Test condition

Stroke	5 mm
Grease quantity	2.5 cc/1 Ball slide
Total stroke	10 million times

#### ▶ Comparison of linear guide track surfaces after operation (measured in the long direction of the ball slide)

##### General grease

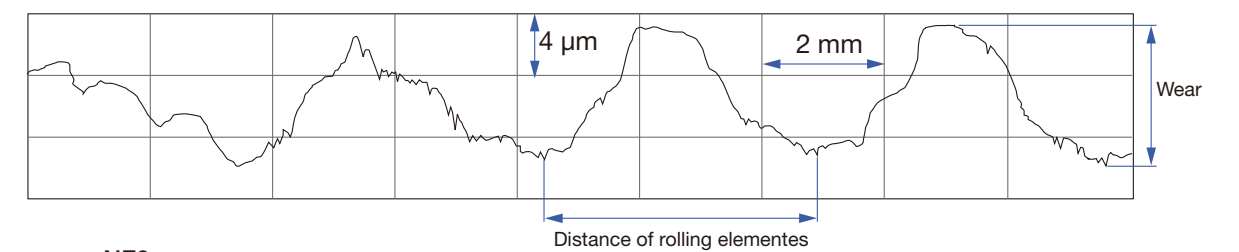

##### NF2 grease

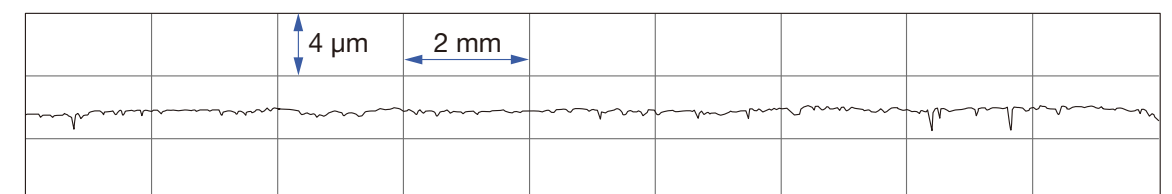

# NSK Grease

## NSK Grease NS7

Reference no. : NSK GRS NS7  
Quantity: 80 g Tube color: Yellow green



Low-temperature

### Feature

It has remarkable torque characteristics (low torque), and can be used wide temperature range.

### Range of use temperature

-40 to +130°C

### Properties

Thickener	Lithium soap
Base oil	Ester oil
Consistency	250
Dropping point	192°C
Volume of evaporation	0.3% (99°C, 22 hr)
Copper plate corrosion test	Satisfactory (100°C, 24 hr)
Oil separation	1.2% (100°C, 24 hr)
Base oil kinematic viscosity	26 mm <sup>2</sup> /s (40°C)

\* For details of NSK Grease NS7, please contact NSK.

## NSK Grease NSL

Reference no. : NSK GRS NSL  
Quantity: 80 g Tube color: Purple



Oscillation

High-speed

### Feature

It has anti-fretting property and superb torque characteristics (low torque) for high-speed operation.

### Range of use temperature

-40 to +130°C

### Properties

Thickener	Lithium soap
Base oil	Synthetic hydrocarbon oil + ester oil
Consistency	280
Dropping point	200°C
Volume of evaporation	0.31% (99°C, 22 hr)
Copper plate corrosion test	Satisfactory (100°C, 24 hr)
Oil separation	1.3% (100°C, 24hr)
Base oil kinematic viscosity	169 mm <sup>2</sup> /s (40°C)

\* For details of NSK Grease NSL, please contact NSK.

# Standard grease

The greases (or rust preventive oil) on the table below will be packed into the products if not specified.

## Packed grease for NSK Linear Guides

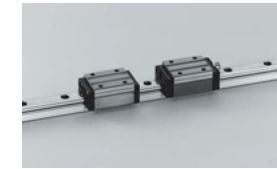

Series	Packed grease
LH	AS2
SH	
VH	
TS	
LS	
SS	
LW	PS2
PU	
LU	
PE	AS2
LE	
RA	
LA	
HA	
HS	



## Packed grease for Ball Screws

"φ\*\*×\*\*\*" in model indicates shaft dia. and lead of ball screw.

Series	Model	Packed grease			
Finished shaft end	Compact FA	High-accuracy, clean	USS	LG2	
		General	PSS	φ12 or less	PS2
				φ15 or over	LR3
	Transfer equipment	FSS	LR3		
	Blank shaft end	Miniature, fine lead	MA	PS2	
		Small equipment	FA	φ10×4, φ12×5	PS2
except above				LR3	
Machine tools		SA	Rust preventive agent		
Stainless steel		KA	Rust preventive agent		
Transfer equipment		VFA	LR3		
	RMA	Rust preventive agent			
	Miniature, fine lead	MS	Rust preventive agent		
	Small equipment	FS	Rust preventive agent		
	Machine tools	SS	Rust preventive agent		
	Transfer equipment	RMS	Rust preventive agent		
		RNFTL	Rust preventive agent		
		RNFBL	Rust preventive agent		
RNCT		Rust preventive agent			
	RNFCL	Rust preventive agent			
	RNSTL	Rust preventive agent			

\* Please apply lubricant (oil or grease) before use for the products which only rust preventive agent is applied at time of delivery.

## Packed grease for Monocarriers

Series	Packed grease
MCM	AS2
MCH	

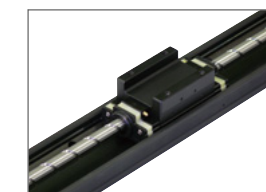

# NSK Hand Grease Pump Unit

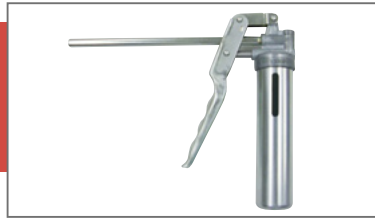

## Feature

- ▶ **Easy operation**  
Can be operated by one hand, yet there is no worry to making a mistake.
- ▶ **Inserting by high pressure**  
Insert at 15 MPa.
- ▶ **No leaking**  
Does not leak when held upside down.
- ▶ **Easy to change grease**  
Simply attach grease in bellows tubes.
- ▶ **Prevents entry of foreign matter**  
Foreign matter such as dust cannot enter since grease can be changed while in bellows tubes.
- ▶ **Remaining grease**  
Can be confirmed through slit on pump.
- ▶ **Several nozzles**  
Six types of nozzles and two extension pipes to choose from.

## NSK Hand Grease Pump (Reference number: NSK HGP) (Contains one NSK straight nozzle)

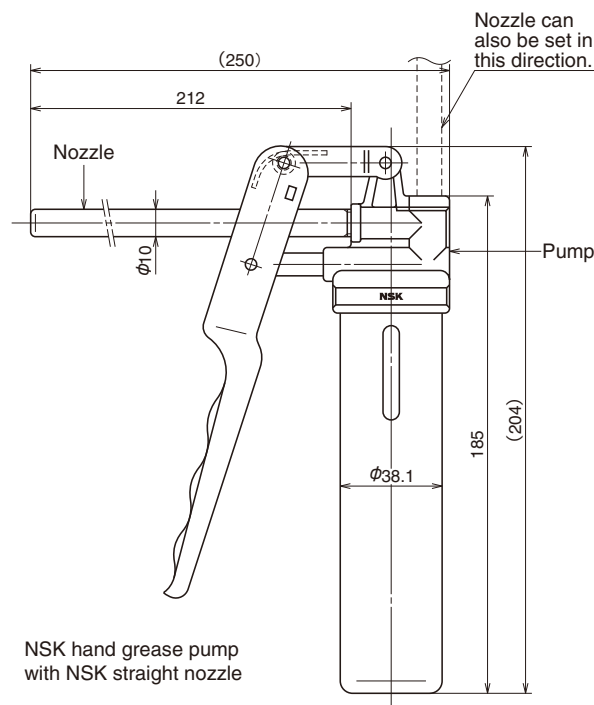

### Specifications

Discharge pressure	15 MPa
Spout volume	0.35cc /shot
Mass of main body (without nozzle)	240 g
Provided nozzle	90 g
Body diameter	φ38.1
Accessory	Several nozzles for a unique application can be attached

## Grease nozzle

### Specifications

Type	Reference no.	Applications	Dimensions
NSK straight nozzle	NSK HGP NZ1	Can be used with grease fitting A, B, and C under JIS B1575 standard.	
NSK chuck nozzle	NSK HGP NZ2	Same as above. However, there is no need to press the hand pump because the grease fitting and the nozzle come to contact due to the chucking mechanism at the tip.	
NSK fitting nozzle	NSK HGP NZ3	Dedicated for the - φ3 drive-in grease fitting.	
NSK point nozzle	NSK HGP NZ4	Used for linear guides and ball screws which do not have grease fitting. Supplies grease directly to the ball grooves, or through the opening of ball slide or ball slide to inside.	
NSK flexible nozzle	NSK HGP NZ5	The tip of the flexible nozzle is chuck nozzle. Used to supply grease to the area where hand cannot reach.	
NSK flexible extension pipe	NSK HGP NZ6	Flexible extension pipe connects the grease pump and the nozzle.	
NSK straight extension pipe	NSK HGP NZ7	Straight extension pipe connects the grease pump and the nozzle.	
NSK MCH exclusive fitting nozzle	NSK HGP NZ8	For MCH Series grease replenishment	

# Applicable Grease Nozzle and Grease Fitting

## ► Grease fitting specifications

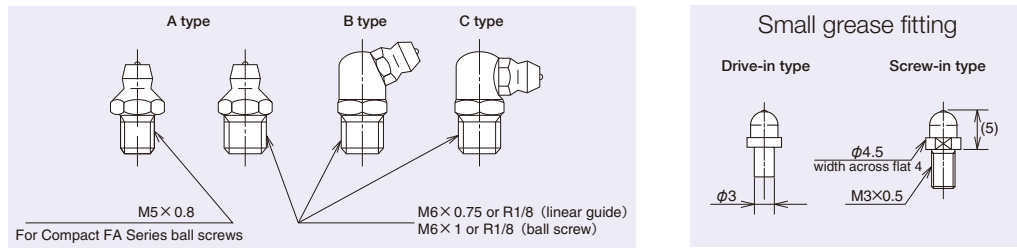

The tables show applicable nozzles and fittings for each products, series and sizes.

## ► Applicable grease nozzles for NSK linear guides

Series	Model No.	Tap hole for grease fitting	Standard grease fitting	Straight nozzle NZ1	Chuck nozzles NZ2	Drive-in fitting nozzle NZ3	Point nozzle NZ4	Flexible nozzle NZ5
LH	LH08, 10	—	—				○	
	LH12, 15	φ 3	Drive-in type			○		
	LH20, 25, 30, 35* <sup>1</sup>	M6×0.75	B type	○	○			○
	LH45, 55, 65	Rc1/8	B type	○	○			○
SH	SH15	φ 3	Drive-in type			○		
	SH20, 25, 30, 35* <sup>1</sup>	M6×0.75	B type	○	○			○
	SH45, 55	Rc1/8	B type	○	○			○
VH	VH15	φ 3	Drive-in type			○		
	VH20, 25, 30, 35* <sup>1</sup>	M6×0.75	B type	○	○			○
	VH45, 55	Rc1/8	B type	○	○			○
	TS	TS15	φ 3	Drive-in type			○	
TS20, 25, 30, 35* <sup>1</sup>		M6×0.75	B type	○	○			○
LS	LS15	φ 3	Drive-in type			○		
	LS20, 25, 30, 35* <sup>1</sup>	M6×0.75	B type	○	○			○
SS	SS15	φ 3	Drive-in type			○		
	SS20, 25, 30, 35* <sup>1</sup>	M6×0.75	B type	○	○			○
LW	LW17	φ 3	Drive-in type			○		
	LW21, 27, 35* <sup>1</sup>	M6×0.75	B type	○	○			○
	LW50	Rc1/8	B type	○	○			○
PU	PU05, 07, 09, 12	—	—				○	
	PU15	φ 3	Drive-in type			○		
LU	LU05, 07, 09, 12, 15	—	—				○	
PE	PE05, 07, 09, 12	—	—				○	
	PE15	φ 3	Drive-in type			○		
LE	LE05, 07, 09, 12, 15	—	—				○	
RA	RA15, 20	φ 3	Drive-in type			○		
	RA25, 30, 35* <sup>1</sup>	M6×0.75	B type	○	○			○
	RA45, 55, 65	Rc1/8	B type	○	○			○
LA	LA25, 30, 35* <sup>1</sup>	M6×0.75	B type	○	○			○
	LA45, 55, 65	Rc1/8	B type	○	○			○
HA	HA25, 30, 35* <sup>1</sup>	M6×0.75	B type	○	○			○
	HA45, 55	Rc1/8	B type	○	○			○
HS	HS15	φ 3	Drive-in type			○		
	HS20, 25, 30, 35* <sup>1</sup>	M6×0.75	B type	○	○			○

\*<sup>1</sup> If using a chuck nozzle, avoid interference with table and rail.

\* For PU, LU, PE, and LE Series, apply grease directly to ball groove, etc. using point nozzle.

\* A long threaded grease fitting is required for NSK linear guides because of dust-proof parts.

## ► Applicable grease nozzle for Ball Screws

Series	Model no.	Tap hole for grease fitting	Standard grease fitting	Straight nozzle NZ1	Chuck nozzles NZ2	Drive-in fitting nozzle NZ3	Point nozzle NZ4	Flexible nozzle NZ5	
									Finished shaft end
Compact FA	High-accuracy, clean	USS	M5×0.8	A type	○	○		○	
	General	PSS	M5×0.8	A type	○	○		○	
	Transfer equipment	FSS	M5×0.8	A type	○	○		○	
Miniature, fine lead	MA	Shaft dia. 12 or less	—	—			○		
		Shaft dia. 16 or over	M6×1	—	○	○		○	
Small equipment	FA	M6×1	—	○	○			○	
Machine tools	SA	Shaft dia. 36 or less	M6×1	—	○	○		○	
		Shaft dia. 40 or over	Rc1/8	—	○	○		○	
Stainless steel	KA	Shaft dia. 12 or less and lead 2 or less except above	M3×0.5	—		○			
		Shaft dia. 12 or less	φ 2.7	—			○		
Transfer equipment	VFA	Shaft dia. 15 or over	φ 3.5	—			○		
		—	—	—			○		
Miniature, fine lead	MS	Shaft dia. 12 or less	—	—			○		
		Shaft dia. 16 or over	M6×1	—	○	○		○	
Small equipment	FS	M6×1	—	○	○			○	
Machine tools	SS	Shaft dia. 36 or less	M6×1	—	○	○		○	
		Shaft dia. 40 or over	Rc1/8	—	○	○		○	
Blank shaft end	Transfer equipment	RMS	—	—			○		
		RNFTL	Shaft dia. 12 or less	M3×0.5	—		○		
			Shaft dia. 14 or over	M6×1	—	○	○		○
		RNFBL	Shaft dia. 12 or less	M3×0.5	—		○		
			Shaft dia. 14 or over	M6×1	—	○	○		○
		RNCT	—	—				○	
		RNFCL	Shaft dia. 12 or less	M3×0.5	—			○	
Shaft dia. 15 or over	M6×1		—	○	○		○		
RNSTL	M6×1	—	○	○			○		

\* Normally, grease fitting is not provided to NSK ball screw except Compact FA Series. Ball nut has a tap hole to install a grease fitting. The user should install a grease fitting if necessary.

\* For M3×0.5 tap hole, small fitting (screw-in type) is available. Please contact NSK.

\* VFA type cannot install grease fitting. Apply grease directly to inside the nut through oil hole using point nozzle.

\* MA, RMA, MS, RMS, and RNCT types have no tap hole, apply grease directly to the screw shaft and ball grooves using point nozzle.

## ► Applicable grease nozzles for Monocarriers

Series	Model no.	Tap hole for grease fitting	Standard grease fitting	Straight nozzle NZ1	Chuck nozzles NZ2	Drive-in fitting nozzle NZ3	Flexible nozzle NZ5	MCH exclusive fitting nozzle NZ8
MCM	MCM02	—	—					
	MCM03, 05, 08, 10	φ 3	Drive-in type			○		○*
	MCM06	M6×0.75	A type	○	○		○	
MCH	MCH06, 09, 10	φ 3	Drive-in type					○

\* Use of NZ3 is recommended.



# Before use of NSK Linear Guides, Ball Screws and Monocarriers

Wipe off rust preventive oil before use if it is supplied to the products.  
 For the products not applied grease, try the system a few times (operate the ball slide of linear guide, ball nut of ball screw or monocarrier slider for whole stroke length 5 to 10 times) after supplying grease, and wipe off excess grease.

# Intervals of checks and replenishments

Although the grease is of high quality, it gradually deteriorates and its lubrication function diminishes. Also, the grease in the ball slide, ball nut and monocarrier slider is gradually removed by stroke movement. In some environments, the grease becomes dirty, and foreign objects may enter. Grease should be replenished depending on frequency of use. The following is a guide of grease replenishment intervals.

Intervals of checks	Items to check	Intervals of replenishments
3 - 6 months	Dirt, foreign matters such as cutting chips	Usually once per year. Every 3 000 km for material handling system that travels more than 3 000 km per year. Replenish if checking results warrant it necessary.

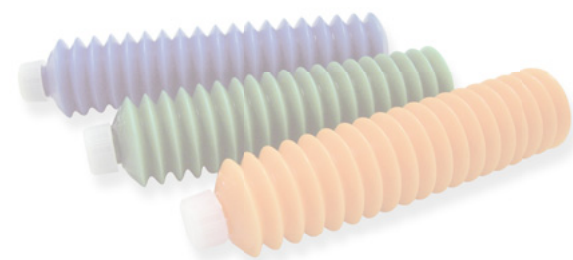

# How to replenish the grease and volume of grease replenished

Supply required amount through grease fitting by a grease pump. Wipe off old grease and accumulated dust before supplying new grease. If grease fitting is not used, or there is no holes for grease replenishment, apply grease directly to the rail or to the ball groove of the screw shaft, and move a ball slide, ball nut or monocarrier slider few strokes so the grease permeates into the ball slide, monocarrier slider and inside the nut.

Once grease is replenished, another supply is not required for a long time. But under some operational conditions, it is necessary to periodically replenish grease. When replenishing using a grease pump, fill the inside of ball slide, ball nut and monocarrier slider with grease. Supply grease until it comes out from the ball slide, ball nut or monocarrier slider area. Move ball slide, ball nut and monocarrier slider by hand while filling them with grease, so the grease permeates all areas. Do not operate the machine immediately after replenishing. Always try the system a few times to spread the grease throughout the system and to remove excess grease. Trial operations are necessary because the resistance to sliding force and screw torque greatly increases immediately after replenishment (full-pack state) and may cause problems. Wipe off excess grease that accumulates at end of rail and screw shaft after trial runs so the grease does not move to other areas.

## How to replenish

- 1 Wipe off old greases on the rail and screw shaft by clean cloth.
- 2 Supply grease until it comes out from the ball slide or ball nut area. Move the ball slide or ball nut by hand while filling them with grease.
- 3 Full-pack state.

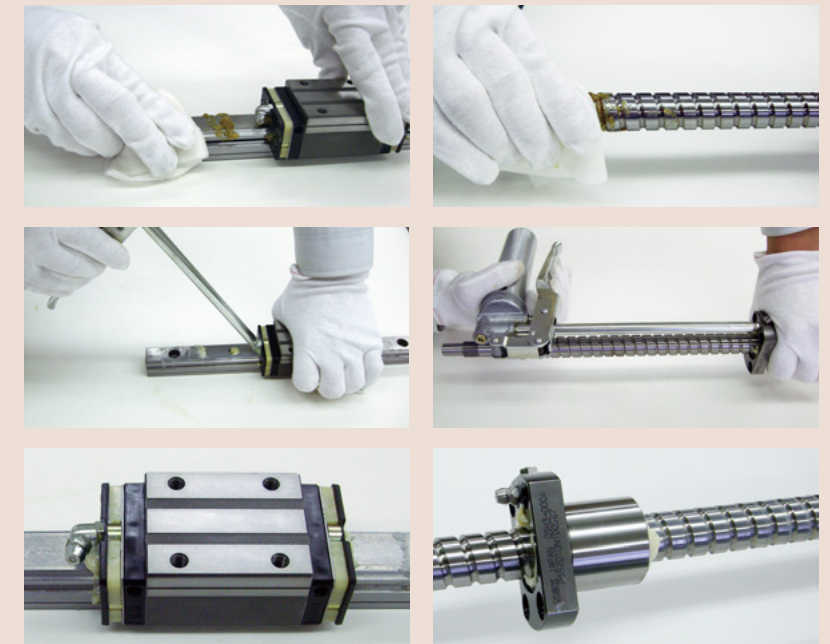

# Internal space

Refer to the tables below for the grease quantity of full-pack state.

## Inside space of the ball slide of linear guide

### ▶ LH, SH Series

Unit: cm<sup>3</sup>

Series Model No.	LH		SH	
	High-load type	Super-high-load type	High-load type	Super-high-load type
08	0.2	—	—	—
10	0.4	—	—	—
12	1.2	—	—	—
15	3	4	2	3
20	6	8	5	7
25	9	13	9	12
30	13	20	11	17
35	22	30	20	27
45	47	59	42	53
55	80	100	73	93
65	139	186	—	—

### ▶ LW Series

Unit: cm<sup>3</sup>

Series Model No.	LW
17	3
21	3
27	7
35	24
50	52

### ▶ RA Series

Unit: cm<sup>3</sup>

Series Model No.	RA	
	High-load type	Super-high-load type
15	1.0	1.5
20	2	2.5
25	3	3.5
30	5	6
35	6	8
45	10	13
55	15	20
65	33	42

### ▶ LA Series

Unit: cm<sup>3</sup>

Series Model No.	LA	
	High-load type	Super-high-load type
25	8	12
30	14	18
35	21	29
45	38	48
55	68	86
65	130	177

### ▶ HA, HSシリーズ

Unit: cm<sup>3</sup>

Series Model No.	HA	HS
15	—	5
20	—	9
25	16	16
30	27	25
35	42	40
45	67	—
55	122	—

### ▶ VH Series

Unit: cm<sup>3</sup>

Series Model No.	VH	
	High-load type	Super-high-load type
15	3	4
20	6	8
25	9	13
30	13	20
35	22	30
45	47	59
55	80	100

### ▶ PU, LU Series

Unit: cm<sup>3</sup>

Series Model No.	PU		LU	
	Standard type	High-load type	Standard type	High-load type
05	0.1	—	0.1	—
07	0.1	—	0.1	—
09	0.2	0.3	0.2	0.3
12	0.3	0.4	0.3	0.4
15	0.8	1.1	0.8	1.1

## Inside space of ball nut

### ▶ Compact FA PSS, USS and FSS types

Shaft dia. × Lead (mm)	Inside space (cm <sup>3</sup> )	Shaft dia. × Lead (mm)	Inside space (cm <sup>3</sup> )	Shaft dia. × Lead (mm)	Inside space (cm <sup>3</sup> )	Shaft dia. × Lead (mm)	Inside space (cm <sup>3</sup> )
10×05	0.8	15×05	2	20×05	3.4	25×05	4.4
10×10	0.7	15×10	2	20×10	3.2	25×10	4.7
12×05	1	15×20	2.8	20×20	3.2	25×20	3.9
12×10	1	15×30	3.4	20×30	4.6	25×25	4.3
12×20	1.2			20×40	5.3	25×30	5.5
12×30	1.5			20×60	7	25×50	7.7

\* For other standard ball screws, refer to the catalog "Precision Machine Components".

### ▶ TS Series

Unit: cm<sup>3</sup>

Series Model No.	TS
15	2
20	3
25	6
30	9
35	15

### ▶ PE, LE Series

Unit: cm<sup>3</sup>

Series Model No.	PE		LE		
	Standard type	High-load type	Medium-load type	Standard type	High-load type
05	0.1	—	0.1	0.1	—
07	0.2	—	0.1	0.2	0.3
09	0.4	0.5	0.2	0.4	0.5
12	0.5	0.7	0.3	0.5	0.7
15	1.2	1.6	0.8	1.2	1.6

### ▶ LS, SS Series

Unit: cm<sup>3</sup>

Series Model No.	LS		SS	
	Medium-load type	High-load type	Medium-load type	High-load type
15	2	3	1.5	2
20	3	4	3	4
25	5	8	5	7
30	8	12	7	11
35	12	19	11	17

## Inside space of the slider of monocarrier

Model No.	Lead (mm)	Inside space (cm <sup>3</sup> )	Model No.	Lead (mm)	Inside space (cm <sup>3</sup> )	Model No.	Lead (mm)	Inside space (cm <sup>3</sup> )
MCM03	1	1	MCM06	5	8.3	MCH06	5	4.9
	2	0.9		10	6.5		10	4.7
	10	1.8		20	5.5		20	4.7
	12	1.7	MCM08	5	11.6	MCH09	5	10
MCM05	5	4.2		10	9.8		10	10
	10	4		20	8.7	20	9.7	
	20	2.1		30	7.2	MCM10	10	17.8
MCM10	10	19.4	20	17.4	20		16.2	
	30	13.6	30	13.6				

# Precautions



- Do not mix greases of different brands because the grease structure may be destroyed.
- Grease viscosity varies by temperature. Viscosity is particular high in winter due to low temperatures. Pay attention to increases in linear guide and monocarrier sliding resistance, and ball screw and monocarrier torque in such conditions.
- When the ambient temperature is low, or in Winter, if it is difficult to pump out the grease from the container, wait until the grease is softened.
- In locations where coolant is dispersed or scattered, emulsification of lubricants and rinsing with water may significantly deteriorate the integrity of the lubricant and the efficacy of the grease. Protect the grease unit from coolant by shielding it with a cover, etc.

# Other

## MSDS (Material Safety Data Sheet)

If you wish to obtain a copy of an MSDS, please contact NSK.

### Explanation of term

Term	Explanation	Test condition
Thickener	A tiny-fibrillate or granular aggregate that maintains base oil by capillary action. Metallic soap thickeners include a versatile lithium-type, while non-soap thickener include a urea-type, which is high-temperature resistant.	—
Base oil	A synthetic fluid, such as mineral oil, silicone oil, or diesters is used as the base oil of a grease. Since the lubrication a grease provides depends mainly on that of the base oil, the viscosity of the base oil must be as carefully selected as the lubricant.	—
Consistency	The depth a cone of a standard weight reaches when dropped onto grease. Consistency indicates the hardness of grease and helps estimate the fluidity of grease when used. When viscosity is high, the grease is soft, and when viscosity is low, the grease is hard.	JIS K 2220 – 7.
Drop point	The temperature at which heated grease in a small, standardized container turns to a liquid state. In general, this indicates the highest temperature at which excessive separation of oil or drippings have not yet started.	JIS K 2220 – 8.
Evaporation rate	The amount of evaporated grease in a mass percentage after maintaining the grease at a certain temperature and subjecting it to heated air for 22 hours. The lower the value, the better, since grease tends to solidify and provide poor lubrication if the amount of evaporation is high.	JIS K 2220 – 10.
Copper plate corrosion	The result of inspecting whether a polished copper plate changes color to green or black after maintaining the plate in room temperature or 100°C for 24 hours. Use of industry-standardized copper plates is advised.	JIS K 2220 – 9.
Oil releasing	The amount of oil separated from grease in a metallic net after maintaining it at temperature of 100°C for 24 hours. If the rate at which the oil is release is low, it may result in poor lubrication, and if the rate is high, the life of the grease may be shortened.	JIS K 2220 – 11.
Base oil viscosity	The speed (duration of time) at which a base oil passes through a thin pipe due to its own weight. The value is calculated by dividing viscosity by density. Generally, high kinetic viscosity indicates better load bearing, but produces larger viscosity resistance in high-speed operations.	JIS K 2283 – 5.

# Introduction of greases for bearings (reference)

\* Greases below cannot be attached to NSK hand grease pump.

## NSK Grease FM1 (NSK GRS FM1) Quantity: 80 g Tube color: Gold

Fluorochemical grease for a wide variety of uses, with superb torque characteristics at low temperatures and long-term lubrication properties at high temperatures. Range of allowable temperatures: -40 to +160°C.



Thickener	Polytetrafluoroethylene [PTFE]
Base oil	Perfluoropolyether
Consistency	325
Dropping point	—
Volume of evaporation	0.5% (150°C, 22 hr)
Copper plate corrosion test	Satisfactory (100°C, 24 hr)
Oil separation	1.00% (100°C, 24 hr)
Base oil kinematic viscosity	85 mm <sup>2</sup> /s (40°C)

## Greases for machine tools spindles

### NSK Grease MTS (NSK GRS MTS)

Quantity: 100 g (Available in 1 kg cans)  
Tube color: Black

Contains urea thickener and delivers higher heat resistance. Recommended for use with ultra high speed machine tool spindles. Allowable temperature range is -40 to +130°C.



Thickener	Urea
Base oil	Mixed synthetic oil
Consistency	275
Dropping point	>220°C
Volume of evaporation	0.30%
Copper plate corrosion test	Satisfactory (100°C, 24 hr)
Oil separation	0.40%
Base oil kinematic viscosity	22 mm <sup>2</sup> /s (40°C)

### NSK Grease MTE (NSK GRS MTE)

Quantity: 100 g (Available in 1 kg cans)  
Tube color: Black

Formulated to handle higher load capacities. Recommended for use in high speed machine tool spindles. Allowable temperature range is -20 to +130°C.



Thickener	Barium complex
Base oil	Ester oil
Consistency	290
Dropping point	>200°C
Volume of evaporation	0.20%
Copper plate corrosion test	Satisfactory (100°C, 24 hr)
Oil separation	1.00%
Base oil kinematic viscosity	23 mm <sup>2</sup> /s (40°C)

# Worldwide Sales Offices and Manufacturing Plants

P: Phone F: Fax C: Country Code Printed in Japan

## NSK LTD.-HEADQUARTERS, TOKYO, JAPAN

Nissei Bldg., 1-6-3 Ohsaki, Shinagawa-ku, Tokyo 141-8560, Japan  
**INDUSTRIAL MACHINERY BUSINESS DIVISION-HEADQUARTERS**  
 P: 03-3779-7227 F: 03-3779-7644 C: 81  
**GLOBAL AFTERMARKET DEPARTMENT**  
 P: 03-3779-7253 F: 03-3779-7644 C: 81  
**PRECISION MACHINERY DEPARTMENT**  
 P: 03-3779-7163 F: 03-3779-7644 C: 81  
**MECHATRONICS BUSINESS DEPARTMENT**  
 P: 0466-21-3027 F: 0466-21-3206 C: 81  
**AUTOMOTIVE BUSINESS DIVISION-HEADQUARTERS**  
 P: 03-3779-7189 F: 03-3779-7917 C: 81

### ●Africa

**South Africa:**  
**NSK SOUTH AFRICA (PTY) LTD.**  
 JOHANNESBURG 25 Galaxy Avenue, Linbro Business Park, Sandton, Gauteng, P.O. Box 1157, Kelvin, 2054, South Africa  
 P: 011-458-3600 F: 011-458-3608 C: 27

### ●Asia and Oceania

**Australia:**  
**NSK AUSTRALIA PTY. LTD.**  
**MELBOURNE** 11 Dalmore Drive, Scoresby, Victoria 3179, Australia  
 P: 03-9765-4400 F: 03-9764-8304 C: 61  
**SYDNEY** 24-28 River Road West, Parramatta, New South Wales 2150, Australia  
 P: 02-8843-8100 F: 02-9893-8406 C: 61  
**BRISBANE** 1/69 Selhurst Street, Coopers Plains, Queensland 4108, Australia  
 P: 07-3347-2600 F: 07-3345-5376 C: 61  
**PERTH** Unit 1, 71 Tacoma Circuit, Canning Vale, Western Australia 6155, Australia  
 P: 08-9256-5000 F: 08-9256-1044 C: 61

### China:

**NSK HONG KONG LTD.**  
**HONG KONG** Suite 705, 7th Floor, South Tower, World Finance Centre, Harbour City, T.S.T, Kowloon, Hong Kong, China  
 P: 02739-9933 F: 02739-9323 C: 852  
**SHENZHEN** Room 624-626, 6/F, Kerry Center, Renminnan Road, Shenzhen, Guangdong, China  
 P: 0755-25904886 F: 0755-25904883 C: 86

**KUNSHAN NSK CO., LTD.**  
**OFFICE/PLANT** 258 South Huang Pu Jiang Rd., Kunshan Economic & Technical Development Zone, Jiangsu, China (215335)  
 P: 0512-5771-5654 F: 0512-5771-5689 C: 86

**CHANGSHU NSK NEEDLE BEARING CO., LTD.**  
**OFFICE/PLANT** No. 66 Dongnan Road, Changshu Southeast Economic Development Zone, Changshu City, Jiangsu, China (215500)  
 P: 0512-5230-1111 F: 0512-5230-6011 C: 86

**NSK STEERING SYSTEMS DONGGUAN CO., LTD.**  
**OFFICE/PLANT** High-tech Park, Shilong Road, Guanlong Section, Dongguan, Guangdong, China (523119)  
 P: 0769-2262-0960 F: 0769-2316-2867 C: 86

**ZHANGJIAGANG NSK PRECISION MACHINERY CO., LTD.**  
**OFFICE/PLANT** No. 34 Zhenxing Road, Zhangjiagang Economic Development Zone, Zhangjiagang City, Jiangsu, China (215600)  
 P: 0512-5867-6496 F: 0512-5818-0970 C: 86

**SUZHOU NSK BEARINGS CO., LTD.**  
**OFFICE/PLANT** No. 22 Taishan Road, Suzhou New District, Jiangsu, China (215129)  
 P: 0512-6665-5666 F: 0512-6665-9138 C: 86

**NSK (CHINA) RESEARCH & DEVELOPMENT CO., LTD.**  
**JIANGSU** No.8 NSK Rd., Huaqiao Economic Development Zone, Kunshan, Jiangsu, China (215332)  
 P: 0512-5796-3000 F: 0512-5796-3300 C: 86

**NSK (SHANGHAI) TRADING CO., LTD.**  
**HEAD OFFICE** No.8 NSK Rd., Huaqiao Economic Development Zone, Kunshan, Jiangsu, China (215332)  
 P: 0512-5796-3000 F: 0512-5796-3300 C: 86

**NSK (CHINA) INVESTMENT CO., LTD.**  
**HEAD OFFICE** No.8 NSK Rd., Huaqiao Economic Development Zone, Kunshan, Jiangsu, China (215332)  
 P: 0512-5796-3000 F: 0512-5796-3300 C: 86

**BEIJING** Room 2116, Beijing Fortune Bldg., 5 Dong San Huan Bei Lu, Chao Yang District, Beijing, China (100004)  
 P: 010-6590-8161 F: 010-6590-8166 C: 86

**TIAN JIN** Room 06, 09F The Exchange Tower 2, No. 189 NanJing Road, Heping District, Tianjin, China (300050)  
 P: 022-8319-5030 F: 022-8319-5033 C: 86

**CHANGCHUN** Room 1001, Building A, Zhongyin Building, 727 Xi'an Road, Changchun, Jilin, China (130061)  
 P: 0431-8898-8882 F: 0431-8898-8670 C: 86

**SHENYANG** Room 1101, China Resources Building, No. 286 Qingnian Street, Heping District, Shenyang Liaoning, China (110004)  
 P: 024-2334-2868 F: 024-2334-2058 C: 86

**DALIAN** Room 1805 Xiwang Tower, No.136 Zhongshan Road, Zhongshan District, Dalian, Liaoning, China (116001)  
 P: 0411-8800-8168 F: 0411-8800-8160 C: 86

**NANJING** Room A1 22F, Golden Eagle International Plaza, No.89 Hanzhong Road, Nanjing, Jiangsu, China (210029)  
 P: 025-8472-6671 F: 025-8472-6687 C: 86

**FUZHOU** Room 1801-1811, B1#1A Class Office Building, Wanda Plaza, No.8 Aojiang Road, Fuzhou, China (350009)  
 P: 0591-8380-1030 F: 0591-8380-1225 C: 86

**WUHAN** Room 2108, New World International Trade Tower I, No.568 Jianshe Road, Wuhan, Hubei, China (430000)  
 P: 027-8556-9630 F: 027-8556-9615 C: 86

**QINGDAO** Room 802, Farglory International Plaza, No.26 Xianggang Zhong Road, Shinan District, Qingdao, Shandong, China (266071)  
 P: 0532-5568-3877 F: 0532-5568-3876 C: 86

**GUANGZHOU** Room 2302, TaiKoo Hui Tower 1, No.385 Tianhe Road, Tianhe District, Guangzhou, China (510620)  
 P: 020-3817-7800 F: 020-3786-4501 C: 86

**CHANGSHA** Room 1048, 10/F, Zhongtian Plaza, No.766 WuyiRoad, Changsha, Hunan, China (410005)  
 P: 0731-8571-3100 F: 0731-8571-3255 C: 86

**LUOYANG** Room 1108, Fangda Hotel, 6 XiYuan Road, LuoYang HeNan, China (471003)  
 P: 0379-6069-6188 F: 0379-6069-6180 C: 86

**XI'AN** Room 1007, B Changan Metropolis Center88 Nanguanzheng Steet, Xi'an, Shanxi, China (710068)  
 P: 029-8765-1896 F: 029-8765-1895 C: 86

**CHONGQING** Room 2306, Unit B, No.137, Keyuan 2nd Road, Jiulongpo District, Chongqing, China (400039)  
 P: 023-6806-5310 F: 023-6806-5292 C: 86

**CHENGDU** Room1117, Lippo Tower, No.62 North Kehua Road, Chengdu, Sichuan, China (610041)  
 P: 028-8528-3680 F: 028-8528-3690 C: 86

**NSK CHINA SALES CO., LTD.**  
**HEAD OFFICE** No.8 NSK Rd., Huaqiao Economic Development Zone, Kunshan, Jiangsu, China (215332)  
 P: 0512-5796-3000 F: 0512-5796-3300 C: 86

**NSK-WARNER (SHANGHAI) CO., LTD.**  
**OFFICE/PLANT** No. 2518 Huancheng Road (West) Fengxian District, Shanghai, China (201401)  
 P: 021-3365-5757 F: 021-3365-5262 C: 86

**AKS PRECISION BALL (HANGZHOU) CO., LTD.**  
**PLANT** No. 189 Hongda Road, Xiaoshan Area of Economic & Technological Development Zone, Hangzhou, Zhejiang, China (311231)  
 P: 0571-2280-1288 F: 0571-2280-1268 C: 86

**NSK-YAGI PRECISION FORGING (ZHANGJIAGANG) CO., LTD.**  
**PLANT** No. 34 Zhenxing Road, Zhangjiagang Economic Development Zone, Zhangjiagang City, Jiangsu, China (215600)  
 P: 0512-5867-6496 F: 0512-5818-0970 C: 86

**NSK-WANDA ELECTRIC POWER ASSISTED STEERING SYSTEMS CO.,LTD.**  
**OFFICE/PLANT** 1833 Yatal Road, Wenyan Town, Xiaoshan, Hangzhou, Zhejiang, China (311258)  
 P: 0571-8231-4818 F: 0571-8248-6656 C: 86

**SHENYANG NSK PRECISION CO., LTD.**  
**OFFICE/PLANT** No. 7, 15 Street, Shenyang Economic & Technological Development Area, Shenyang, Liaoning, China (110141)  
 P: 024-2550-5017 F: 024-2532-6081 C: 86

**SHENYANG NSK CO., LTD.**  
**OFFICE/PLANT** No. 5, 15 Street, Shenyang Economic & Technological Development Area, Shenyang, Liaoning, China (110141)  
 P: 024-2532-6080 F: 024-2532-6081 C: 86

**India:**  
**RANE NSK STEERING SYSTEMS LTD.**  
**CHENNAI** 14, Rajagopalan Salai, Vallancherry, Guduvancherry, Tamil Nadu-603 202, India  
 P: 044-474-06017 F: 044-274-66001 C: 91

**BAWAL** Plot No.28A, Sector 6, HSIDC Growth Centre Bawal, District Rewari, Haryana -123 501, India  
 P: 01284-264281 F: 01284-264280 C: 91

**NSK INDIA SALES CO.PVT.LTD.**  
**CHENNAI** 6th Floor, Bannari Amman Towers, No.29 Dr. Radhakrishnan Salai, Mylapore, Chennai-600 004 Tamil Nadu, India  
 P: 044-2847-9600 F: 044-2847-9601 C: 91

**GURGAON** Unit No-202, 2nd Floor, Block-A, Iris Tech Park, Sector-48, Gurgaon, Haryana-122008, India  
 P: 0124-4104-530 F: 0124-4104-532 C: 91

**KOLKATA** 502, Trinity Towers, 83, Toppia Road, Kolkata-700 046, India  
 P: 033-4001-2062 F: 033-4001-2064 C: 91

**MUMBAI** 321, 'A' Wing, Ahura Centre, 82, Mahakali Caves Road, Andheri (East), Mumbai -400 093, India  
 P: 022-2838-7787 F: 022-2838-5191 C: 91

**NSK-ABC BEARINGS LTD.**  
**OFFICE/PLANT** Plot No.A2, SIPCOT Growth Centre, Oragadam, Mathur Village, Sriperumbudur Taluk, Kancheepuram District, Tamil Nadu-802 105, India  
 P: 044-2714-3000 F: 044-2714-3099 C: 91

**Indonesia:**  
**PT. NSK BEARINGS MANUFACTURING INDONESIA**  
**JAKARTA PLANT** Blok M4, Kawasan Berikat MM2100 Industrial Town Cikarang Barat, Bekasi 17520, Indonesia  
 P: 021-898-0155 F: 021-898-0156 C: 62

**PT. NSK INDONESIA**  
**JAKARTA** Summitmas II, 6th Floor, Jl. Jend Sudirman Kav. 61-62, Jakarta 12190, Indonesia  
 P: 021-252-3458 F: 021-252-3223 C: 62

**PT. NSK-WARNER INDONESIA**  
**BEKASI** MM2100 Industrial Town, Cikarang Barat, Bekasi 17520, Indonesia  
 P: 021-8998-3216 F: 021-8998-3218 C: 62

**Korea:**  
**NSK KOREA CO., LTD.**  
**SEOUL** Posco Center (West Wing) 9F, 892, Daechi-4Dong, Kangnam-Ku, Seoul, 135-777, Korea  
 P: 02-3287-0300 F: 02-3287-0345 C: 82

**CHANGWON PLANT** 60, Seongsan-Dong, Changwon, Kyungsangnam-Do, 642-315, Korea  
 P: 055-287-6001 F: 055-285-9982 C: 82

**Malaysia:**  
**NSK BEARINGS (MALAYSIA) SDN. BHD.**  
**HEAD OFFICE** No. 2, Jalan Pemaju, U1/15, Seksyen U1, Hicom Glenmarie Industrial Park, 40150 Shah Alam, Selangor, Malaysia  
 P: 03-7803-8859 F: 03-7806-5982 C: 60

**PRAI** No.36, Jalan kikik, Taman Inderawasih, 13600 Prai, Penang, Malaysia  
 P: 04-3902275 F: 04-3991830 C: 60

**JOHOR BAHRU** 88 Jalan Ros Merah 2/17, Taman Johor Jaya, 81100 Johor Bahru, Johor, Malaysia  
 P: 07-3546290 F: 07-3546291 C: 60

**IPOH** Gr. Floor, 89 Jalan Bendahara, 31650 Ipoh, Perak, Malaysia  
 P: 05-2555000 F: 05-2553373 C: 60

**NSK MICRO PRECISION (M) SDN. BHD.**  
**MALAYSIA PLANT** No.43 Jalan Taming Dua, Taman Taming Jaya 43300 Balakong, Selangor Darul Ehsan, Malaysia  
 P: 03-8961-3960 F: 03-8961-3968 C: 60

**New Zealand:**  
**NSK NEW ZEALAND LTD.**  
**AUCKLAND** 3 Te Apunga Place, Mt. Wellington, Auckland, New Zealand  
 P: 09-276-4992 F: 09-276-4082 C: 64

**Philippines:**  
**NSK REPRESENTATIVE OFFICE**  
**MANILA** 8th Floor The Salcedo Towers 169 H.V. dela Costa St., Salcedo Village Makati City, Philippines 1227  
 P: 02-893-9338 F: 02-893-9173 C: 63

**Singapore:**  
**NSK INTERNATIONAL (SINGAPORE) PTE LTD.**  
**SINGAPORE** 238A, Thomson Road, #24-01/05, Novena Square Tower A, Singapore 307684  
 P: 6496-8000 F: 6250-5845 C: 65

**NSK SINGAPORE (PRIVATE) LTD.**  
**SINGAPORE** 238A, Thomson Road, #24-01/05, Novena Square Tower A, Singapore 307684  
 P: 6496-8000 F: 6250-5845 C: 65

# Worldwide Sales Offices and Manufacturing Plants

P: Phone F: Fax C: Country Code Printed in Japan

**Taiwan:**  
**TAIWAN NSK PRECISION CO., LTD.**  
**TAIPEI** 11F., No.87, Song Jiang Rd., Jhongshan District, Taipei City 104, Taiwan R.O.C.  
 P: 02-2509-3305 F: 02-2509-1393 C: 886

**TAICHUNG** 107-7, Sec. 3, Wen Xing Rd., Taichung City 407, Taiwan R.O.C.  
 P: 04-2311-7978 F: 04-2311-2627 C: 886

**TAINAN** 5F, No.8, Daye 1st Rd., Southern Taiwan Science Park, Tainan City 741, Taiwan R.O.C.  
 P: 06-505-5861 F: 06-505-5061 C: 886

**TAIWAN NSK TECHNOLOGY CO., LTD.**  
**TAIPEI** 11F., No.87, Song Jiang Rd., Jhongshan District, Taipei City 104, Taiwan R.O.C.  
 P: 02-2509-3305 F: 02-2509-1393 C: 886

**TAICHUNG** 10F-3, No.123, Sec.3, Junggang Rd., Taichung 407, Taiwan R.O.C.  
 P: 04-2358-2945 F: 04-2358-7682 C: 886

**TAINAN** 5F, No.8, Daye 1st Rd., Southern Taiwan Science Park, Tainan City 741, Taiwan R.O.C.  
 P: 06-505-5861 F: 06-505-5061 C: 886

**Thailand:**  
**NSK BEARINGS (THAILAND) CO.,LTD.**  
**BANGKOK** 26 Soi Onnuch 55/1 Pravet Subdistrict, Pravet District, Bangkok 10250, Thailand  
 P: 02320-2555 F: 02320-2826 C: 66

**NSK BEARINGS MANUFACTURING (THAILAND) CO., LTD.**  
**OFFICE/PLANT** 700/430 Moo 7, Amata Nakorn Industrial Estate, T.Donhualor, A.Muangchonburi, Chonburi 20000, Thailand  
 P: 038-454-010 F: 038-454-017 C: 66

**SIAM NSK STEERING SYSTEMS CO., LTD.**  
**OFFICE/PLANT** 90 Moo 9, Wellgrow Industrial Estate, Km.36 Bangna-Trad Rd., Bangwao, Bangpakong, Chachoengsao 24180, Thailand  
 P: 038-522-343 F: 038-522-351 C: 66

**NSK ASIA PACIFIC TECHNOLOGY CENTRE (THAILAND) CO., LTD.**  
**CHONBURI** 700/430 Moo 7, Amata Nakorn Industrial Estate, T.Donhualor, A.Muangchonburi, Chonburi 20000, Thailand  
 P: 038-454-631 F: 038-454-634 C: 66

**Vietnam:**  
**NSK VIETNAM CO., LTD.**  
**HEAD OFFICE** Techno Center, Room 204-205, Thang Long Industrial Park, Dong Anh District, Hanoi, Vietnam  
 P: 04-3955-0159 F: 04-3955-0158 C: 84

**NSK REPRESENTATIVE OFFICE**  
**HO CHI MINH CITY** Suite 307, Metropolitan Building, 235 Dong Khoi Street, District 1, HCMC, Vietnam  
 P: 08-3822-7907 F: 08-3822-7910 C: 84

**●Europe**  
**NSK EUROPE LTD. (EUROPEAN HEADQUARTERS)**  
**MAIDENHEAD** Belmont Place, Belmont Road, Maidenhead, Berkshire SL6 6TB, U.K.  
 P: 01628-509-800 F: 01628-509-808 C: 44

**France:**  
**NSK FRANCE S.A.S.**  
**PARIS** Quartier de l'Europe, 2 Rue Georges Guynemer, 78283 Guyancourt, France  
 P: 01-30-57-39-39 F: 01-30-57-00-01 C: 33

**Germany:**  
**NSK DEUTSCHLAND GMBH**  
**HEAD OFFICE** Harkortstrasse 15, D-40880 Ratingen, Germany  
 P: 02102-4810 F: 02102-4812-290 C: 49

**STUTT GART** Liebknechtstrasse 33, D-70565 Stuttgart-Vaihingen, Germany  
 P: 0711-79082-0 F: 0711-79082-289 C: 49

**WOLFSBURG** Heinrich-Nordhoff-Strasse 101, D-38440 Wolfsburg, Germany  
 P: 05361-27647-10 F: 05361-27647-70 C: 49

**NEUWEG FERTIGUNG GMBH**  
**OFFICE/PLANT** Ehinger Strasse 5, D-89597 Munderkingen, Germany  
 P: 07393-540 F: 07393-5414 C: 49

**Italy:**  
**NSK ITALIA S.P.A.**  
**MILANO** Via Garibaldi 215, Garbagnate Milanese (Milano) 20024, Italy  
 P: 0299-5191 F: 0299-025778 C: 39

**Netherlands:**  
**NSK EUROPEAN DISTRIBUTION CENTRE B.V.**  
 De Kroonstraat 38, 5048 AP Tilburg, Netherlands  
 P: 013-4647647 F: 013-4647648 C: 31

**Poland:**  
**NSK EUROPE LTD. REPRESENTATIVE OFFICE**  
**WARSAW** Ul. Migdalowa 4/73, 02-796, Warsaw, Poland  
 P: 022-645-1525 F: 022-645-1529 C: 48

**NSK BEARINGS POLSKA S.A.**  
**OFFICE/PLANT** Ul. Jagiellonska 109, 25-734 Kielce, Poland  
 P: 041-366-5001 F: 041-367-0500 C: 48

**NSK STEERING SYSTEMS EUROPE (POLSKA) SP.Z O.O.**  
**CORPORATE** Ul. Mariana Jachimowicza 17, 58-306 Walbrzych, Poland  
**OFFICE/PLANT** P: 074-664-4101 F: 074-664-4104 C: 48

**NSK NEEDLE BEARING POLAND SP.Z O.O.**  
**OFFICE/PLANT** Ul. Jagiellonska 109, 25-734 Kielce, Poland  
 P: 041-345-2469 F: 041-345-0361 C: 48

**NSK POLSKA SP.Z O.O.**  
**KIELCE** Ul. Karczowkowska 41, 25-711 Kielce, Poland  
 P: 041-347-5110 F: 041-347-5101 C: 48

**Spain:**  
**NSK SPAIN S.A.**  
**BARCELONA** C/Tarragona 161, 2a Planta, 08014, Barcelona, Spain  
 P: 093-433-5775 F: 093-433-5776 C: 34

**Turkey:**  
**NSK RULMANLARI ORTA DOGU TIC. LTD. STI.**  
**ISTANBUL** 19 Mayıs Mah. Atatürk Cad. Ulya Engin Is Merkezi No. 68 Kat. 6, Kozyatagi 34734, Istanbul, Turkey  
 P: 0216-355-0398 F: 0216-355-0399 C: 90

**United Kingdom:**  
**NSK BEARINGS EUROPE LTD.**  
**PETERLEE** 3 Brindley Road, South West Industrial Estate, Peterlee, Co. Durham SR8 2JD, U.K.  
 P: 0191-586-6111 F: 0191-586-3482 C: 44

**NEWARK** Northern Road, Newark, Nottinghamshire NG24 2JF, U.K.  
 P: 01636-605-123 F: 01636-605-000 C: 44

**NSK EUROPEAN TECHNOLOGY CENTRE**  
**NEWARK** Northern Road, Newark, Nottinghamshire NG24 2JF, U.K.  
 P: 01636-605-123 F: 01636-643-241 C: 44

**NSK UK LTD.**  
**NEWARK** Northern Road, Newark, Nottinghamshire NG24 2JF, U.K.  
 P: 01636-605-123 F: 01636-605-000 C: 44

### ●North and South America

**NSK AMERICAS, INC. (AMERICAN HEADQUARTERS)**  
**ANN ARBOR** 4200 Goss Road, Ann Arbor, Michigan 48105, U.S.A.  
 P: 734-913-7500 F: 734-913-7511 C: 1

**Argentina:**

