

- 16mm to 50mm Screw Diameters
- 16mm to 100mm Leads
- Dynamic Loads up to 7,220 kgf
- Static Loads up to 21,974 kgf
- Right Helix Standard
- C7 Standard Accuracy
- P1 Standard Preload
- Other Accuracies and Preloads available upon request

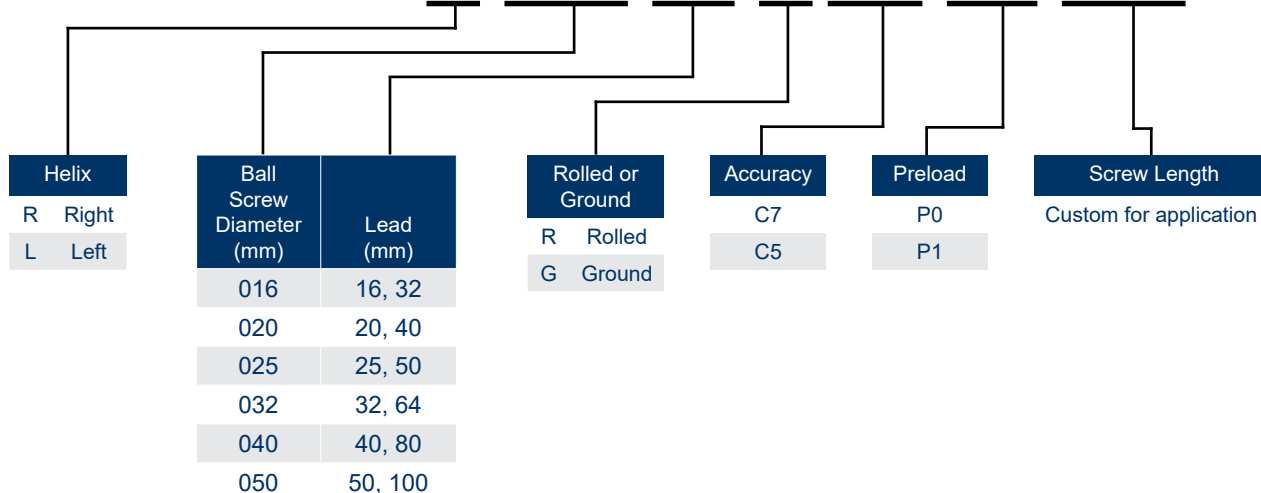

The SYA Series screw diameters range from 16mm to 50mm with leads from 16mm to 100mm. This series can provide dynamic loads up to 7,220 kgf and static loads up to 21,974 kgf. Although we provide C7 and C5 accuracies and P0 and P1 preloads as our standard, other accuracies and preloads are available upon request. Maximum screw length is 6,000mm and we can customize end journals to best fit your application.

BSC-AAM-SYAR-016-16-R C7-P1-500



L011949

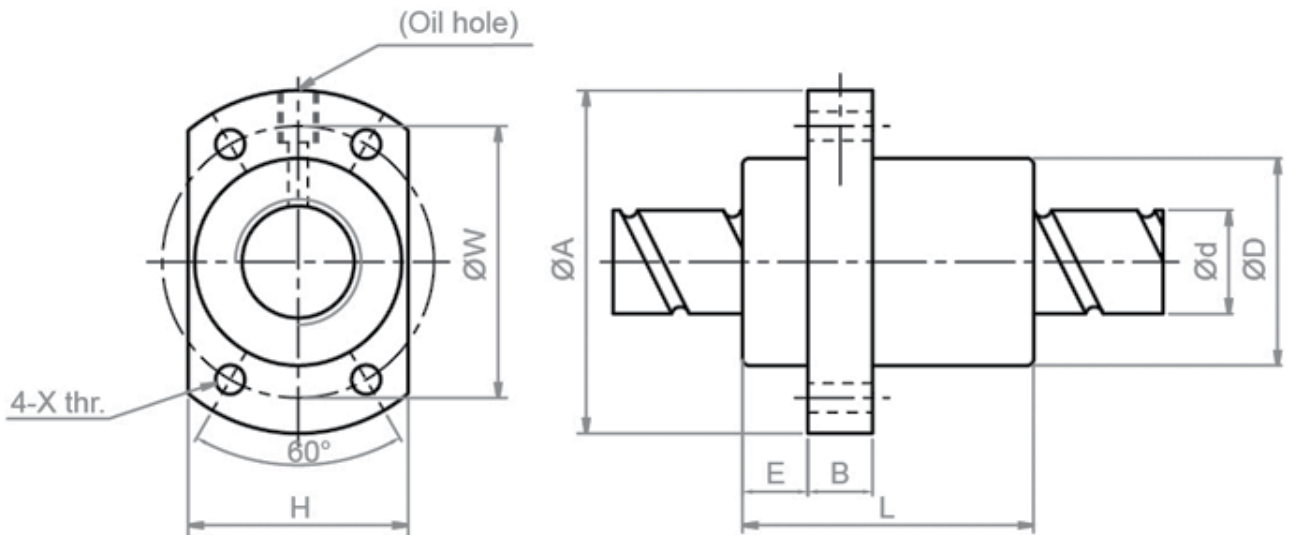

Units : mm

Model No.	d	l	Da	D	A	E	B	L	X	W	H	Q	n	Ca	Coa	K	H*
BSC-AAM-SYAR-016-16	16	16	2.778	32	53	10.1	10	45	4.5	42	34	M6	1.8x2	1073	2551	31	R
BSC-AAM-SYAR-016-32	16	32	2.778	32	53	10.1	10	42.5	4.5	42	34	M6	0.8x2	493	1116	11	R
BSC-AAM-SYAR-020-20	20	20	3.175	39	62	13	10	52	5.5	50	41	M6	1.8x2	1387	3515	37	R
BSC-AAM-SYAR-020-40	20	40	3.175	39	62	13	10	48	5.5	50	41	M6	0.8x2	653	1597	15	R
BSC-AAM-SYAR-025-25	25	25	3.969	47	74	15	12	64	6.6	60	49	M6	1.8x2	2074	5494	45	R
BSC-AAM-SYAR-025-50	25	50	3.969	47	74	15	12	58	6.6	60	49	M6	0.8x2	976	2495	19	R
BSC-AAM-SYAR-032-32	32	32	4.762	58	92	17	12	78	9	74	60	M6	1.8x2	3021	8690	58	R
BSC-AAM-SYAR-032-64	32	64	4.762	58	92	17	12	71	9	74	60	M6	0.8x2	1374	3571	22	R
BSC-AAM-SYAR-040-40	40	40	6.35	73	114	19.5	15	99	11	93	75	M6	1.8x2	4831	14062	70	R
BSC-AAM-SYAR-050-50	50	50	7.938	90	135	21.5	20	117	14	112	92	M6	1.8x2	7220	21974	86	R
BSC-AAM-SYAR-040-80	40	80	6.35	73	114	19.5	15	90	11	93	75	M6	0.8x2	2273	6387	29	R
BSC-AAM-SYAR-050-100	50	100	7.938	90	135	21.5	20	111	14	112	92	M6	0.8x2	3398	9980	35	R

*PLEASE NOTE - Each standard ball screw includes **one** nut. Additional nuts will be considered a custom request, and will require creation of a special part number.