

# KNC-SRV-FD114S Series Servo Driver



## FEATURES

- 24-70VDC
- Rated Current is (RMS) 5A
- 50-100 Watt Rated Power Range
- Position, Speed, and Torque Control
- RS232 and RS485 Port
- Natural Air Cooling
- MODBUS RTU or Pulse and Direction
- Supports Incremental or 16-Bit Absolute Encoders
- Communication Software
  - Configure Parameters
  - I/O Signal Monitoring
  - Speed and Position Curves
  - Gain Adjustments
- Programmable Inputs and Outputs
  - 3 Inputs
  - 2 Outputs (1 Standard & 1 for Brake)
- CE Certified



## DESCRIPTION

The KNC-SRV-FD114S-LB-000 Series Servo Drive is a great fit for applications requiring position, speed, and/or torque control methods. The uniqueness of this Servo Drive is the flexibility of using a single Servo Drive that can accommodate motors with power ratings ranging from 50-100W. Also, it is designed to switch dynamically among different control methods for more flexible operation. The KNC-SRV-FD114S-LB-000 Servo Drive can operate position control mode either with pulse and direction inputs, 8 internal position points, or 8 internal speed points. The KNC-SRV-FD114S-LB-000 Servo Drive operates with a 24-70VDC input. These drives come standard with an RS232 which can be operated using MODBUS Protocol, and RS485, or can be operated using our Free, Easy-to-Use Software. To communicate to the drives, the KNC-SRV-RS-232-RJ45 Cable is required. Please consult our Application Engineers for more information.

## SPECIFICATIONS

Category	Servo Driver	Servo Motor	Description	Power/Brake Cable	Encoder Cable	Rated Power / Rated Speed / Rated Torque
Small Inertia DC48V	FD114S-LB-000	SMC40S-0005-30MAK-5DSU	16-Bit Single-Turn Magnetic Encoder	MOT-005-05-KL-D	ENCHG-05-GU	50W / 3000 RPM / 23 oz-in
		SMC40S-0005-30MBK-5DSU	16-Bit Single-Turn Magnetic Encoder with Brake	MOT-005-05-KL-D / BRA-05-KL	ENCHG-05-GU	50W / 3000 RPM / 23 oz-in
		SMC40S-0010-30MAK-5DSU	16-Bit Single-Turn Magnetic Encoder	MOT-005-05-KL-D	ENCHG-05-GU	100W / 3000 RPM / 45 oz-in
		SMC40S-0010-30MBK-5DSU	16-Bit Single-Turn Magnetic Encoder with Brake	MOT-005-05-KL-D / BRA-05-KL	ENCHG-05-GU	100W / 3000 RPM / 45 oz-in

L011794

# KNC-SRV-FD114S Series Servo Driver



DIMENSIONS

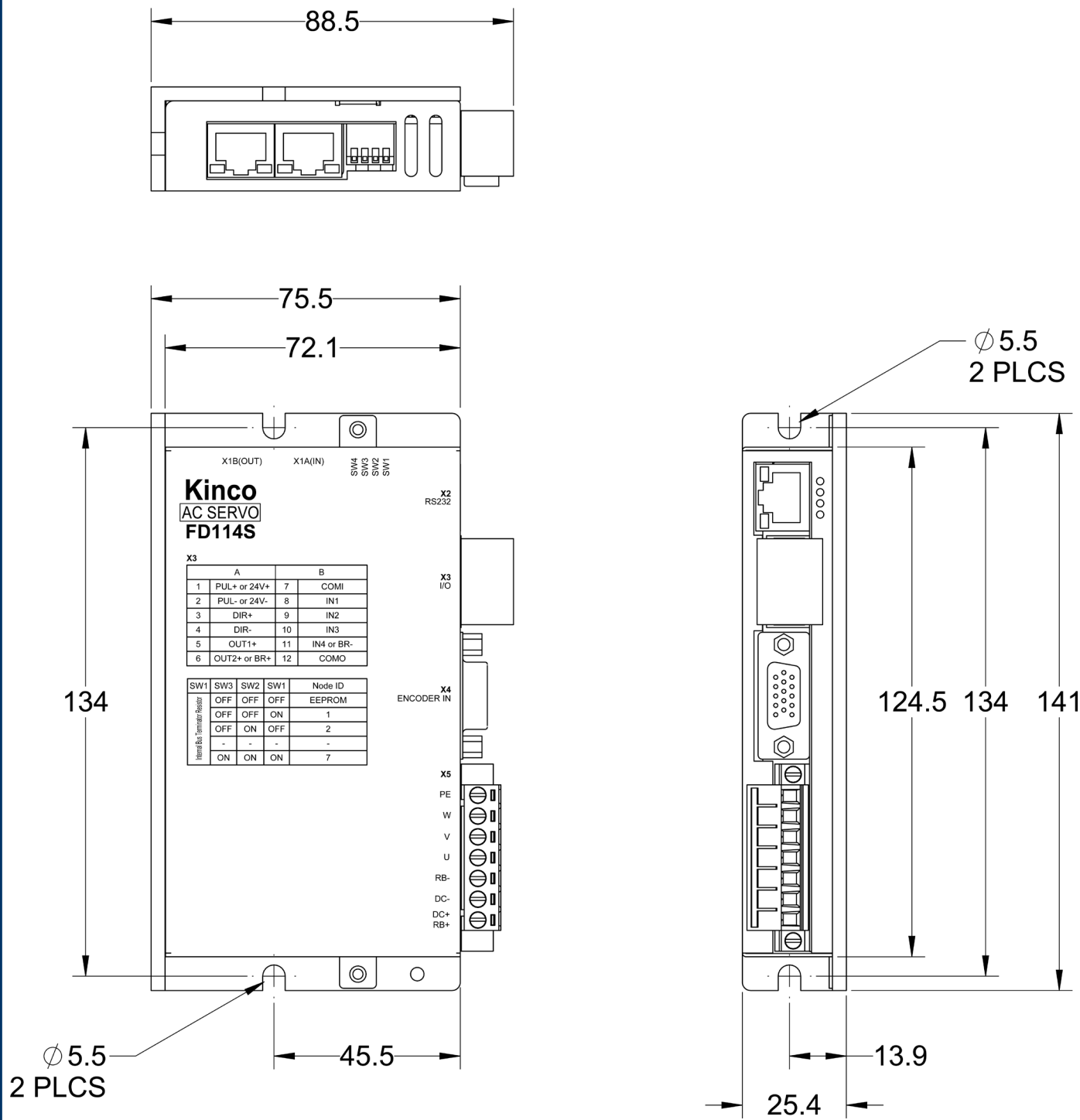

Note: All Dimensions in (mm)

# KNC-SRV-FD114S Series Servo Driver



TECHNICAL SPECIFICATIONS

Model Parameter		KNC-SRV-FD114S Series
Power	Main Supply Voltage	24VDC-70VDC
	Control Circuit Voltage	DC24V 1A (Optional)
Current	Rated Current (RMS)	5Arms
	Peak Current (PEAK)	8A
Feedback Signal		5V Incremental Differential Encoder 16-Bit Single-Turn Magnetic Encoder
Brake Chopper		Via Wiring an External Braking Resistor (Mainly in Quick Start and Stop Application). Brake Chopper Threshold is 73V (Adjustable via Software)
Brake Chopper Threshold		DC73V $\pm$ 2V (Default Value, Adjustable via Software)
Over-Voltage Alarming Threshold		DC83V $\pm$ 2V
Under-Voltage Alarming Threshold		18V $\pm$ 2V
Cooling Method		Natural Air Cooling Note: External Heatsink is Required when the Rated Current of FD114S, FD134S and FD144S Should be Bigger than 12Arms, 20Arms and 30Arms Respectively. The Size of External Heatsink is 300mm*300mm*10mm in Length*Width*Height
Weight		1.1 lbs
Digital Input	Input Specification	3 Digital Inputs, with COM1 Terminal for PNP (High Level Valid 12.5-30V) or NPN (Low Level Valid 0-5V) Connection, Suitable to FD1x4S-LB-000 4 Digital Inputs, with COM1 Terminal for PNP (High Level Valid 12.5-30V) or NPN (Low Level Valid 0-5V) Connection, Suitable to FD1x4S-LA-000
	Input Function	Define Freely According to Requirement, Supporting Following Functions: Driver Enable, Driver Fault Reset, Driver Mode Control, Speed Loop Proportional Control, Positive Limit, Negative Limit, Homing Signal, Reverse Command, Internal Speed Section Control, Internal Positive Section Control, Quick Stop, Start Homing, Active Command, Switch Electronic Gear Ratio, Switch Gain.
Digital Output	Output Specification	1 - Way Digital Output without 1 Driving Capacity of 100 ma or (BR+/BR-) can Directly Drive the Standard Brake Motor for FD1x4S-LB-000, Please Refer to the Wiring Port for Details. 2 - Way Digital Output without 1 Driving Capacity of 100 ma, Suitable for FD1x4S-LA-000.
	Pulse Direction Output	Pulse + Direction, CCW+CW, Phase A+Phase B (5V~24V) Note, only FD1x4-Lx-000 Support this Function
	Output Function	Define Freely According to Requirement, Supporting Following Functions: Driver Ready, Driver Fault, Position Reached, Motor at Zero Speed, Motor Brake, Motor Speed Reached, Z Signal, Maximum Speed Obtained in Torque Mode, Motor Brake, Position Limiting, Reference Found.
	RS232	Default Baudrate Setting is 38400, the Max. Baudrate is 115.2KHz, use Kinco Software to Communicate with PC, or via Free Protocol to Communicate with Controller.
	Protection Function	Over-Voltage Protection, Under-Voltage Protection, Motor Over-Heat Protection ( $I^2T$ ), Short-Circuit Protection, Drive Over-Heat Protection, Etc.
Modbus / RS485		The Max. Baudrate is 115.2KHz, use Modbus RTU Protocol to Communicate with Controller.
CAN BUS		Support Maximum 1MHz Baudrate. Communicate with Controller via CANopen Protocol
Ethercat		Support CoE(CiA402 Protocol) and CSP/CSV/PP/PV/PT/HM Mode, Communication Speed 100M

# KNC-SRV-FD114S Series Servo Driver



INTERFACE DESCRIPTION

RS485 Port

PIN Number	Signal
8	GND
7	NC
6	NC
5	TX+
4	TX-
3	NC
2	RX-
1	RX+

RS485  
Bus Communication Port — X1

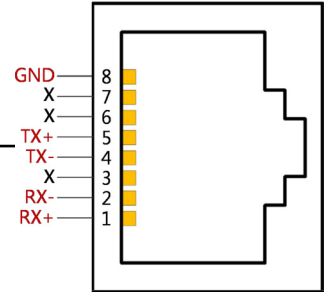

RS232 Port

PIN Number	Signal
3	TX
4	GND
6	RX
Others	NC

RS232 Communication  
Interface, Can be Used for  
Debugging and Import/  
Export Project Data Via PC — X2

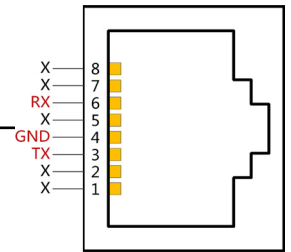

External Input & Output

PIN No.	Signal	PIN No.	Signal
1	PUL+	7	COMI
2	PUL-	8	IN1
3	DIR+	9	IN2
4	DIR-	10	IN3
5	OUT1+	11	IN4 / BR-
6	OUT2+ / BR+	12	COMO

Digital Input/Output  
Terminals — X3

FD1X4S-□B-000

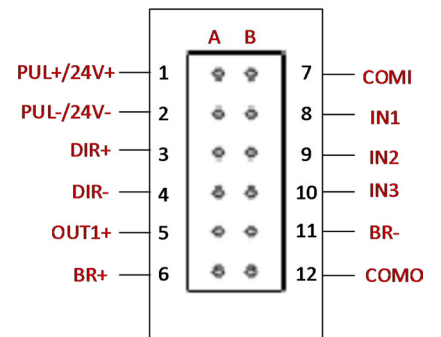

FD1X4S-□A-000

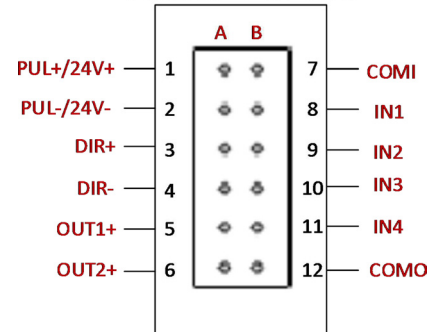

# KNC-SRV-FD114S Series Servo Driver



INTERFACE DESCRIPTION

## Motor with Incremental Encoder

PIN No.	Signal	PIN No.	Signal
1	GND	9	5V+
2	/A	10	A
3	/B	11	B
4	/Z	12	Z
5	/U	13	U
6	/V	14	V
7	/W	15	W
8	PE	16	-

Motor Encoder Input Interface X4

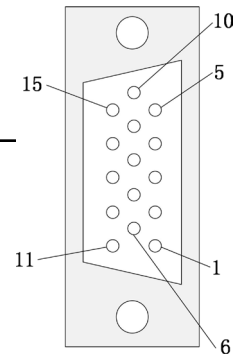

## Motor/Power Supply

PIN Name	PIN Function
PE W V U	Servo Motor UVW phase out and motor ground
RB-	External brake resistor input
DC-	Driver power input negative
DC+ / RB+	Driver power input positive
RB+	External brake resistor input

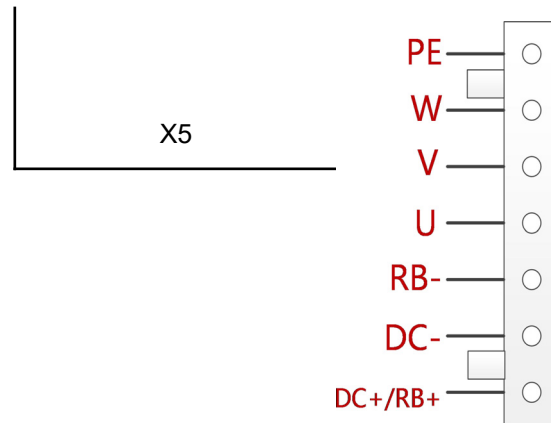

# KNC-SRV-FD114S Series Servo Driver



WIRING

Communication Cable: KNC-SRV-RS-232-RJ45 for KNC-SRV-SMC40S-0005-30MAK-5DSU, KNC-SRV-SMC40S-0005-30MBK-5DSU, KNC-SRV-SMC40S-0010-30MAK-5DSU, KNC-SRV-SMC40S-0010-30MBK-5DSU.

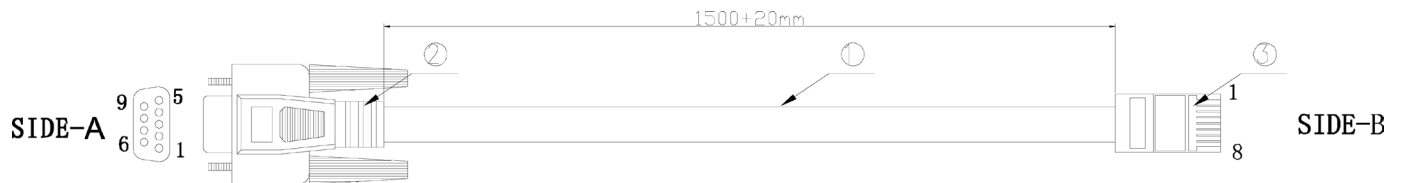

KNC-SRV-RS-232-RJ45								
SIDE-A	2	3	4	5	6	7	8	
SIDE-B	3	6	7	4	5	2	8	1