

KNC-SRV-iSMK60 Integrated Servo System



FEATURES

- 200-400 Watt
- 24-60VDC
- RS485, CANopen (AA), EtherCAT (EA)
- 60mm Frame Size
- Singleturn Magnetic Encoder
- 3000 RPM Rated Speed
- 90.6-179.8 oz-in Rated Torque
- Modbus RTU or CANopen
- Position and Speed Control
- 24V Logic Power Supply



DESCRIPTION

The KNC-SRV-iSMK60 Integrated Servo System includes a 200-400 Watt Servo Motor, operated by the Servo Drive. Each system includes a Servo Motor size of 60mm square, power rating of 200-400 Watts, with a Servo Drive attached to the top of the Servo Motor. These packages are ideal and provide easy start-ups, convenience, and performance. The Servo Motors included in these packages provide torque up to 539.5 oz-in. The Servo Drive is designed to switch dynamically among different control methods for more flexible operation and can operate position control mode either with pulse and direction inputs, internal position points, or internal speed points.

DESCRIPTION

Item	Rated Output Power (Watts)	Rated Voltage (VDC)	Rated Speed (RPM)	Rated Torque (oz-in)	Rated Current (Arms)	Inertia (oz-in-sec ²)	Peak Torque (oz-in)	Max Speed (RPM)	Brake (24VDC)	Motor Length (mm)	Shaft Diameter (mm)
KNC-SRV-ISMK60-020-DMAK-AA-000	200	48	3000	90.6	5.7	0.002407	271.8	3800	No	88	14
KNC-SRV-ISMK60-020-DMBK-AA-000	200	48	3000	90.6	5.7	0.002464	271.8	3800	Yes	127.5	14
KNC-SRV-ISMK60-020-DMAK-EA-000	200	48	3000	90.6	5.7	0.002407	271.8	3800	No	88	14
KNC-SRV-ISMK60-020-DMBK-EA-000	200	48	3000	90.6	5.7	0.002464	271.8	3800	Yes	127.5	14
KNC-SRV-ISMK60-040-DMAK-AA-000	400	48	3000	179.8	10.6	0.004389	539.5	3800	No	106	14
KNC-SRV-ISMK60-040-DMBK-AA-000	400	48	3000	179.8	10.6	0.004446	539.5	3800	Yes	145.5	14
KNC-SRV-ISMK60-040-DMAK-EA-000	400	48	3000	179.8	10.6	0.004389	539.5	3800	No	106	14
KNC-SRV-ISMK60-040-DMBK-EA-000	400	48	3000	179.8	10.6	0.004446	539.5	3800	Yes	145.5	14

ORDERING INFORMATION

KNC-SRV-iSMK60-020-DMAK-AA-000

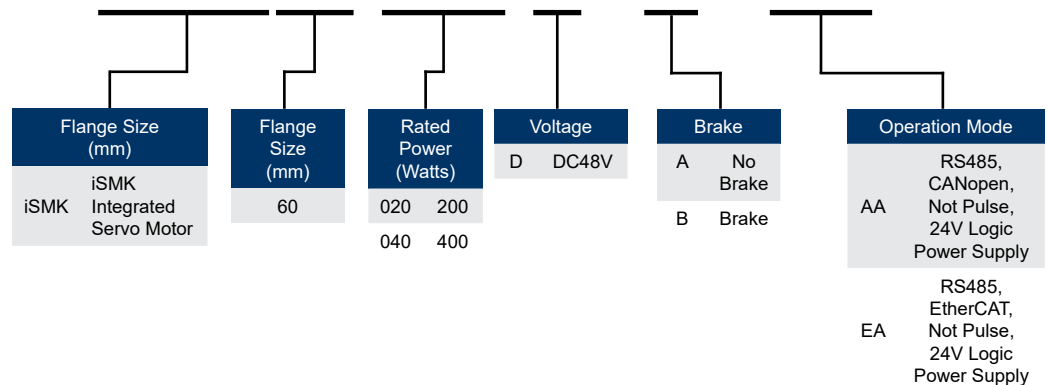

L012017

KNC-SRV-iSMK60 Integrated Servo System



DIMENSIONS

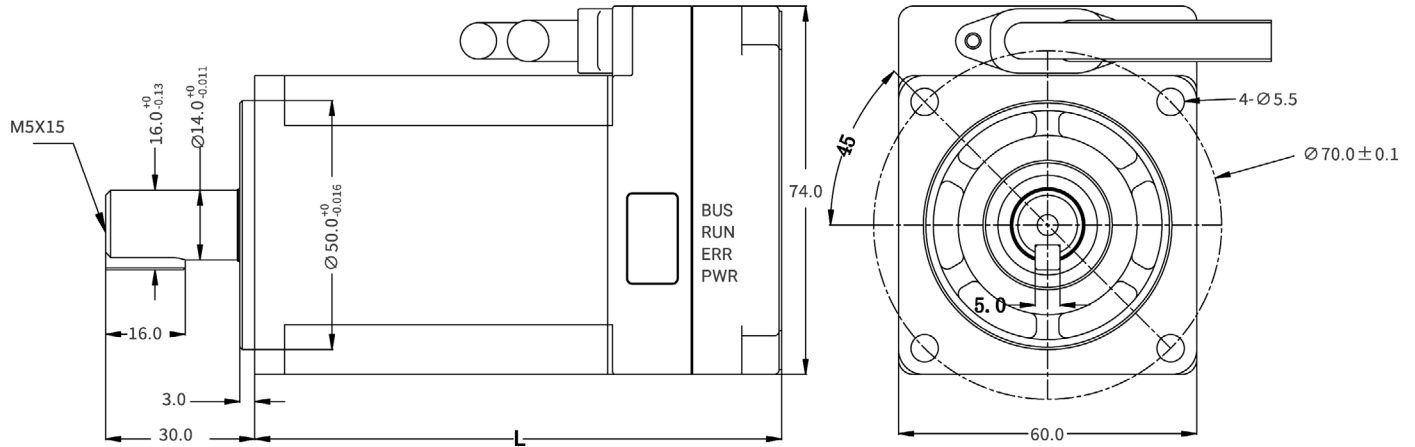

Part #	With Brake	Weight (lbs)	Motor Body Size "L" (mm)
KNC-SRV-ISMK60-020-DMAK-AA-000	No	2.42	88
KNC-SRV-ISMK60-020-DMBK-AA-000	Yes	3.52	127.5
KNC-SRV-ISMK60-020-DMAK-EA-000	No	2.64	88
KNC-SRV-ISMK60-020-DMBK-EA-000	Yes	3.74	127.5
KNC-SRV-ISMK60-040-DMAK-AA-000	No	2.86	106
KNC-SRV-ISMK60-040-DMBK-AA-000	Yes	3.96	145.5
KNC-SRV-ISMK60-040-DMAK-EA-000	No	3.08	106
KNC-SRV-ISMK60-040-DMBK-EA-000	Yes	4.18	145.5

TORQUE CURVE

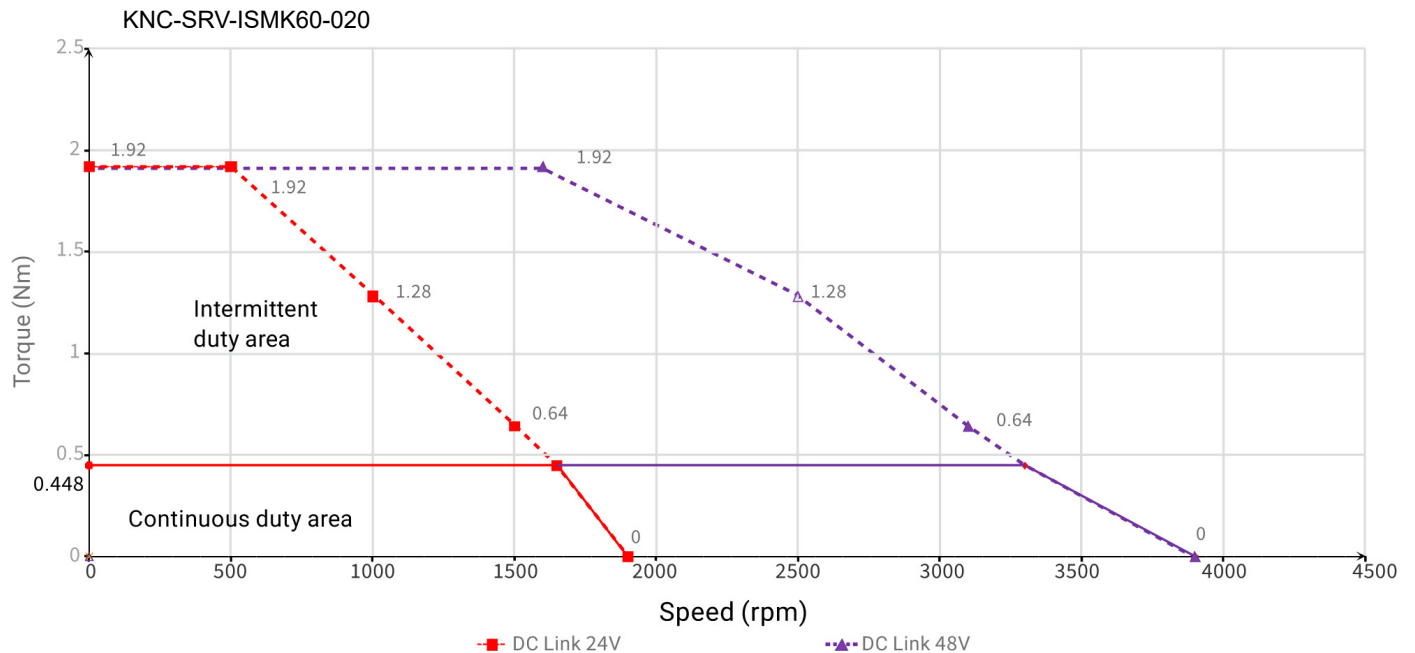

L012017

TORQUE CURVE

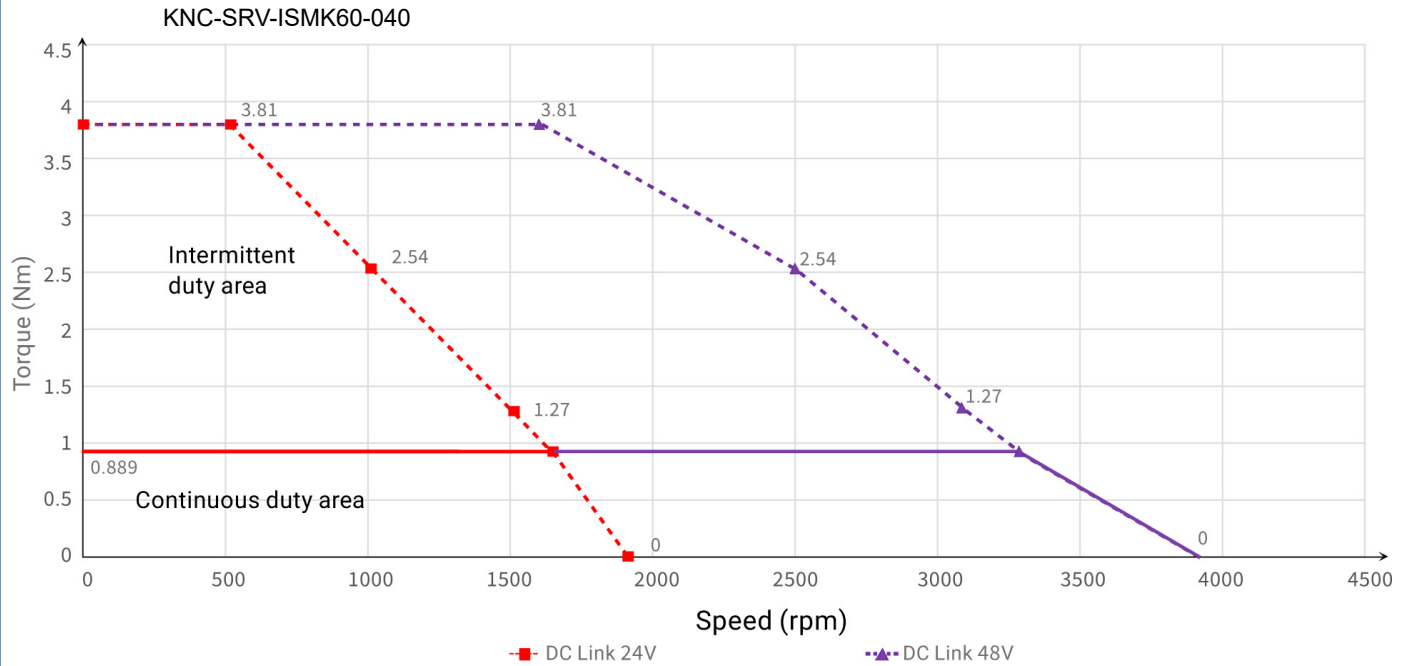

INTERFACE DESCRIPTION

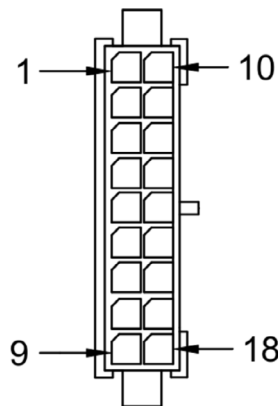

iSMK-AA Communication Terminal

A			B		
Pin	Name	Cable Color	Pin	Name	Cable Color
1	24V	Red	10	GND	Black
2	LOCK+	Purple	11	LOCK-	Purple and Black
3	CANH	Blue and Black	12	CANL	Blue
4	CANH	Blue and Black	13	CANL	Blue
5	RS485A	Orange and Black	14	RS485B	Orange
6	RS485A	Orange and Black	15	RS485B	Orange
7	OUT1+	Yellow and Black	16	COMO	Yellow
8	COMI	White	17	DI1	Green
9	GND	Green and Black	18	DI2	White and Black

L012017

KNC-SRV-iSMK60 Integrated Servo System



INTERFACE DESCRIPTION

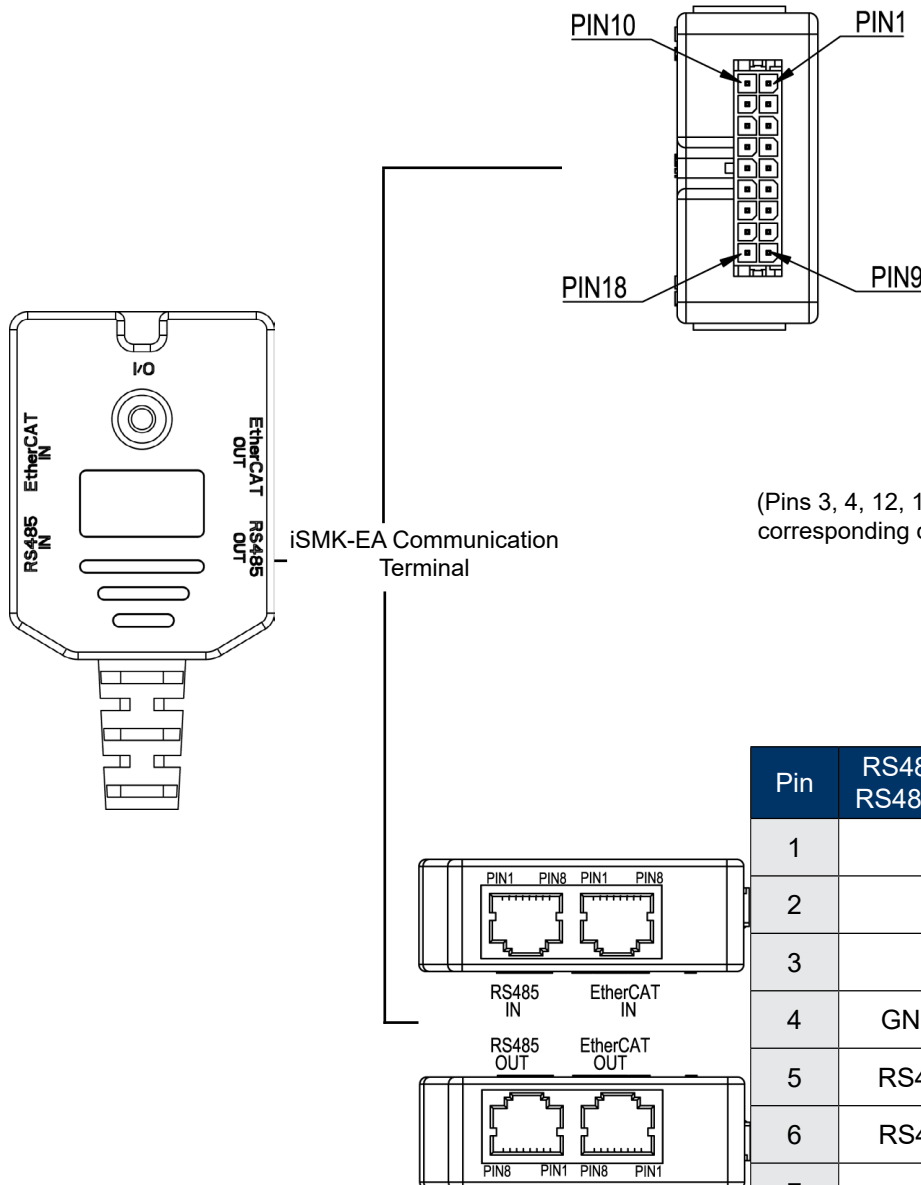

A		B	
Pin	Signal	Pin	Signal
1	24V	10	GND
2	LOCK+	11	LOCK-
3	/	12	/
4	/	13	/
5	RS485A	14	RS485B
6	RS485A	15	RS485B
7	OUT1+	16	COMO
8	COMI	17	DI1
9	GNDC	18	DI2

(Pins 3, 4, 12, 13 of the iSMK-EA series are empty, and the corresponding color cable of these four pins of the external cable can be ignored)

Pin	RS485 IN / RS485 OUT	EtherCAT IN	EtherCAT OUT
1	/	IN TX+	OUT TX+
2	/	IN TX-	OUT TX-
3	/	IN RX+	OUT RX+
4	GND_C	/	/
5	RS485B	/	/
6	RS485A	IN RX-	OUT RX-
7	/	/	/
8	/	/	/

L012017

Signal	Function Description
24V	The logic power supply is an optional option. When using the logic power supply, ensure that the power supply and logic are completely isolated. If the system power supply is not isolated, the logical ground cable is not connected. The logic power supply is connected at DC- and V
GND	Logic electrical reference ground
LOCK+	External release beake input The input voltage is V, the maximum input current is . A, only when the AGV body battery is out of emergency use;
LOCK-	Only when both the logic power supply and the power supply are powered off, the external lock can be unlocked. Do not short-circuit or connect to other signals and enclosures during normal operation
CANH	CAN signal positive end(Only the iSMK-AA series has this terminal)
CANL	CAN signal negative end(Only the iSMK-AA series has this terminal)
485A	RS485 data positive end
485B	RS485 data negative end
GND_C	Signal ground
DIN1	Digital signal input;High level: . VDC~ VDC Low level: VDC~VDC Input impedance: KΩ Input frequency: <KHz
DIN2	Digital signal input;High level: . VDC~ VDC Low level: VDC~VDC Input impedance: KΩ Input frequency: <KHz
COMI	Digital signal input to the common end
OUT1+	Digital signal output; digital output, maximum output current: mA
COMO	Digital signal output common terminal

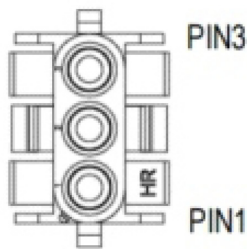

Power Cable Port

Power Line Terminal C6350HM-3P-V0	Signal	Color
1	48V+	Red
2	/	/
3	48V-	Black

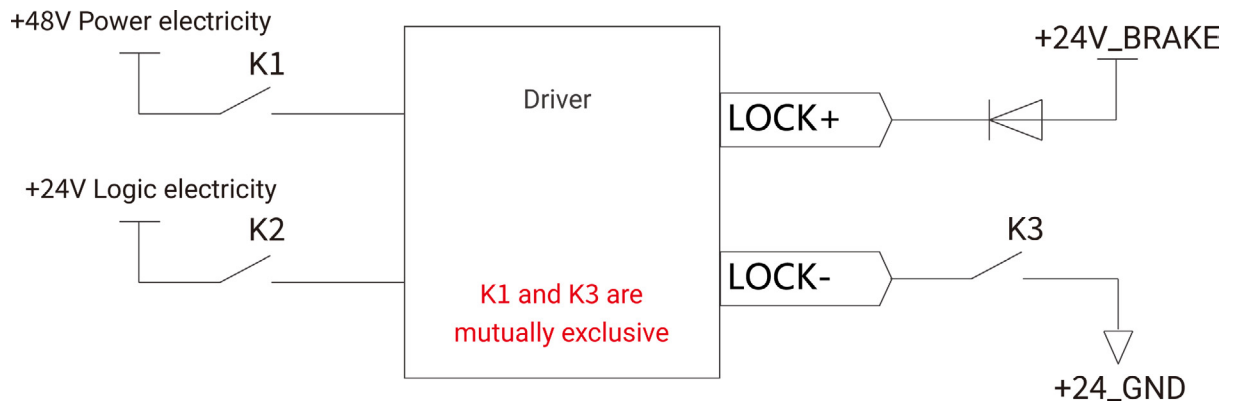

(Note: After cutting off the iSMK logic and power supply, use the power supply)

L012017

KNC-SRV-iSMK60 Integrated Servo System



TECHNICAL SPECIFICATIONS

Model Parameter		KNC-SRV-iSMK60 Series
Power	Main Supply Voltage	DC24V~60V
Current	Rated Current (A)	5.7 (A) for 200 Watt Drivers, 10.6 (A) for 400 Watt Drivers
	Peak Current (PEAK)	17.1 (A) for 200 Watt Drivers, 31.8 (A) for 400 Watt Drivers
Weight (lbs)		2.42 lbs for KNC-SRV-ISMK60-020-DMAK-AA-000 3.52 lbs for KNC-SRV-ISMK60-020-DMBK-AA-000 2.64 lbs for KNC-SRV-ISMK60-020-DMAK-EA-000 3.74 lbs for KNC-SRV-ISMK60-020-DMBK-EA-000 2.86 lbs for KNC-SRV-ISMK60-040-DMAK-AA-000 3.96 lbs for KNC-SRV-ISMK60-040-DMBK-AA-000 3.08 lbs for KNC-SRV-ISMK60-040-DMAK-EA-000 4.18 lbs for KNC-SRV-ISMK60-040-DMBK-EA-000
Logic Loss Power (mW)		900
Feedback Signal		Singleturn Communication Type Magnetolectric Encoder
Energy Consumption Brake		There is no brake circuit inside the driver, and an external brake module is required.
Over-Voltage Alarming Threshold		Default is 70V
Under-Voltage Alarming Threshold		Default is 18V
Cooling Method		Natural Air Cooling
Input Specification		2 Digital Inputs, High: 12.5VDC~30VDC Low: 0VDC~5VDC Input Impedance: 5KΩ Input Frequency: <1KHz
Input Function		Freely defined as required, the functions are as follows: drive enable, drive error reset, drive mode control, speed loop proportional control, positive limit, negative limit, origin signal, command reverse, internal speed segment control, internal position segment control, emergency stop, start to find the origin, command activation, electronic gear ratio switching, gain switching.
Output Specification		1 Digital Output, OUT1 for the open collector output, the highest voltage 30V, driving capacity of 100mA
Output Function		Freely defined according to needs, the functions are as follows: driver ready, driver error, motor position to, motor zero speed, motor lock brake, motor speed to, index Z signal appears, maximum limit speed in torque mode, motor lock shaft, motor limit medium, origin finding.
RS485		It supports a maximum . Kbps baud rate and can communicate with the controller using the Modbus RTU.
CANopen		It supports a maximum Mbps baud rate and can communicate with the controller using the CANopen.
EtherCAT		Support CoE(CiA protocol)and CSP/CSV/PP/PV/PT/HM mode, communication speed M
Operation Environment	Operating Temperature	-20 ~ 40°C (No Freezing) When the operating temperature exceeds 40°C, the driver needs to be derated.
	Operating Humidity	Less than 90%RH (No Condensation)
	Storage Temperature	-40°C~70°C (No Freezing)
	Storage Humidity	90%RH (No Condensation)
	Protection Class	IP65, Shaft End IP54
	Installation Method	Motor Flange Installation (Vertical Side Installation)
	Altitude	Rated Working Altitude at 1000m or Below, Above 1000m: Decreasing 1.5% per 100m Rise, Maximum Altitude 2000m Above Sea Level
Atmospheric Pressure		86kpa~106kpa

L012017