

USER'S MANUAL
MODEL DPS32PG1
DRIVER PACK

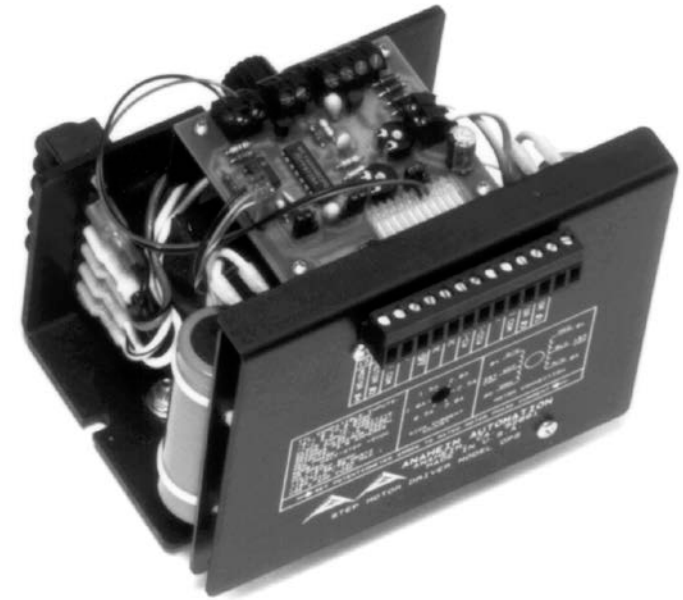

ANAHEIM AUTOMATION
4985 E. Landon Drive
Anaheim, CA 92807
Phone: (714) 992-6990
Fax: (714) 992-0471
<http://www.anaheimautomation.com>
Email: info@anaheimautomation.com

COPYRIGHT

© 1997 by Anaheim Automation. All rights reserved. No part of this publication may be reproduced, transmitted, transcribed, stored in a retrieval system, or translated into any language, in any form or by any means, without the prior written permission of Anaheim Automation, 4985 E. Landon Drive, Anaheim, CA 92807.

DISCLAIMER

Though every effort has been made to supply complete and accurate information in this manual, the contents are subject to change without notice or obligation to inform the buyer. In no event will Anaheim Automation be liable for direct, indirect, special, incidental, or consequential damages arising out of the use or inability to use the product or documentation.

Anaheim Automation does not recommend the use of its' products in life support applications wherein a failure or malfunction of the product may directly threaten life or injury. The user of Anaheim Automation products in life support applications assumes all risks of such use and indemnifies Anaheim Automation against all damages.

LIMITED WARRANTY

All Anaheim Automation products are warranted against defects in workmanship, materials and construction, when used under Normal Operating Conditions and when used in accordance with specifications. This warranty will be in effect for a period of twelve months from the date of purchase or eighteen months from the date of manufacture, whichever comes first. Warranty provisions may be voided if products are subjected to physical modifications, damage, abuse, or misuse.

Anaheim Automation will repair or replace at its' option, any product which has been found to be defective and is within the warranty period, provided that the item is shipped freight prepaid, with previous authorization (RMA#) to Anaheim Automation's plant in Anaheim, California.

TECHNICAL SUPPORT

If you should require technical support or if you have problems using any of the equipment covered in this manual, please read the manual completely to see if it will answer the questions you have. Be sure to look in the TROUBLESHOOTING section located near the back of this manual. If you need assistance beyond what this manual can provide, contact your Local Distributor or the factory direct.

TRADEMARKS

Driver Pack is a registered trademark of Anaheim Automation.

TABLE OF CONTENTS

	PAGE
INTRODUCTION	2
DIMENSIONS	2
DESCRIPTION and FUNCTION	3
BLD72 BILEVEL DRIVE	3
FAULT PROTECTION.....	4
DRIVER JUMPER SETTINGS	4
PULSE GENERATOR	5
HOOKUP DIAGRAM	6
OPERATING MODES	7
RAMPING PROFILES	8
JUMPER LOCATIONS	9
SPECIFICATIONS.....	10
TROUBLESHOOTING.....	13
STANDARD MOTOR TORQUE-SPEED CURVES	14

INTRODUCTION

The ANAHEIM AUTOMATION DPS32PG1 is a step motor Driver Pack that can drive motors rated from 0.5 to 3.5 amps/phase (unipolar rating). DPS32PG1 can handle 6-lead and 8-lead motors. This Driver Pack features a unipolar bilevel (or dual voltage) drive technique with short/open circuit protection (with a Fault LED), and includes the AA2876 Ramping Pulse Generator board with a +5Vdc power supply output. Outstanding motor performance is provided by means of a Bilevel Drive technique. The DPS32PG1's open frame construction is ideal for OEM because of its cost-effective design.

DPS32PG1 Driver Pack features include:

- **Bilevel Drive Operation**
- **100 Watt Transformer**
- **110/220V Operation**
- **Short Circuit Protection**
- **Open Motor Protection**
- **Fault LED**
- **5 Amps/Phase Operating Current**
- **3.5 Amps/Phase Output Current**
- **Unipolar Operation**
- **Half-Step and Full-Step Operation**
- **Motor On/Off Input**
- **Ramping Pulse Generator with Adjustable Base and Max Speeds**
- **No RFI or EMI problems**
- **TTL/CMOS Compatible Inputs**
- **+5Vdc Power Supply Output**

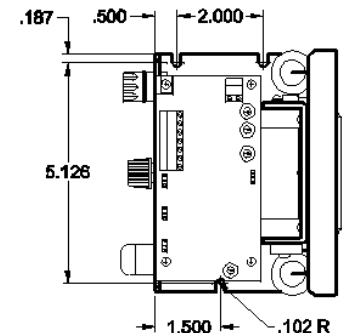
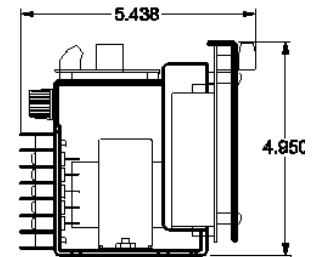

DESCRIPTION AND FUNCTION

BILEVEL DRIVER

The basic function of a motor driver is to provide the rated motor phase current to the motor windings in the shortest possible time. The bilevel driver uses a high voltage to get a rapid rate of current rise in the motor windings in the least amount of time. When reaching the preset trip current, the driver turns off the high voltage and sustains the current from the low voltage supply.

EXCITATION MODE SELECT

Users have a choice of dual-phase, full-step operation or half-step operation. Dual-phase, full-step operation occurs by energizing two phases at a time, rotating a typical motor 1.8 degrees per step. Half-step operation occurs by alternately energizing one, and then two, phases at a time, rotating the motor 0.9 degrees per step. Full-step operation is only suggested for applications that specifically require that mode, such as when retrofitting existing full-step systems.

STEP AND DIRECTION CONTROL

The Clock Output of the AA2876 Pulse Generator is pre-wired to the Clock Input of the driver board through the red molex connector. Terminal 5 is the Direction Input. A Logic "1" on this input selects Clockwise motor direction. A Logic "0" on this input selects Counterclockwise direction.

+5V POWER SUPPLY

This power supply is capable of supplying up to 1.0A to other devices or circuitry. The +12V unregulated voltage may also be used for supplying current to external loads up to 1.5Amps. These outputs can only source a combined total of 1.5 Amps max.

MOTOR ON/OFF INPUT

The Motor On/Off input allows for de-energizing a motor without disturbing the positioning logic. After re-energizing the motor, a routine can continue. This reduces motor heating and conserves power, especially in applications where motors are stopped for long periods and no holding torque is required.

ADJUSTING KICK CURRENT

By following the silkscreen markings on the cover, use a small screwdriver to adjust the potentiometer. Line up the arrow to the number corresponding to the motor's rated current (amps/phase). The kick current is preset for 40 percent over the motor's rated amps/phase.

FAULT PROTECTION

There are three types of fault detection. When a fault is detected, the driver turns off the motor current and the red Fault LED indicates which type of fault occurred.

FAULT PROTECTION

There are three types of fault detection. When a fault is detected, the driver turns off the motor current and the red Fault LED indicates which type of fault occurred. See the Troubleshooting section for more information.

CONDITION		FAULT DETECTED
1	LED - Slow Blink	shorted wire in the motor or cable
2	LED - Fast Blink	open wire in the motor or cable
3	LED - ON Steady	ground fault (voltage shorted to 0V)

TABLE 1: TYPE(S) OF FAULT(S)

If the driver goes into a fault condition, the fault may be reset by turning the power OFF for at least 15 seconds, or by pulling the RESET FAULT input (terminal 4) to a Logic "0" for at least 100ms.

FUNCTION	JP1	JP2	JP3
NEGATIVE GOING CLOCKS	1-2	X	X
POSITIVE GOING CLOCKS	2-3	X	X
TERMINAL 5 = CCW	X	1-2	X
TERMINAL 5 = DIRECTION	X	2-3	X
GROUND FAULT DETECTION ENABLED	X	X	2-3
GROUND FAULT DETECTION DISABLED	X	X	1-2
STANDARD PRODUCT	1 - 2	2 - 3	2 - 3

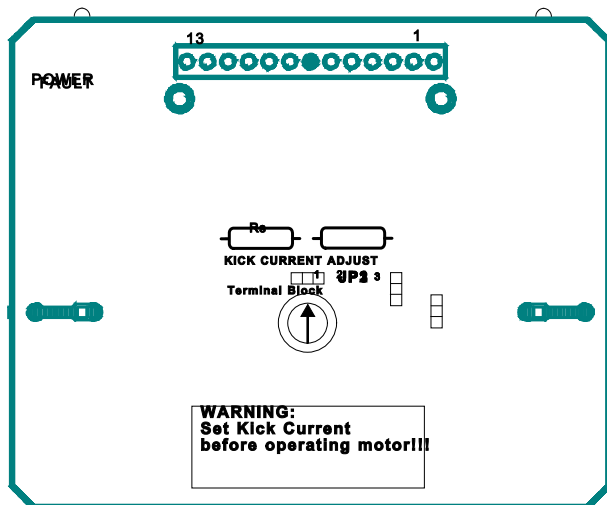

PULSE GENERATOR

The DPS32PG1 contains the AA2876 linear ramping pulse generator (PG). The AA2876 has adjustable BASE and MAX speeds and independent adjustments for acceleration (ramping up) and deceleration (ramping down). The AA2876 also has a VCO Input where the frequency produced is proportional to the voltage on this input. The pulse output is an open collector NPN sinking output.

SPEED RANGES

The AA2876 has an adjustable BASE speed (starting speed) and an adjustable MAX speed (running speed). There are two speed ranges that are jumper selectable. For the low speed range, the BASE speed can be adjusted from 50 pulses/sec to 500 pulses/sec and the MAX speed can be adjusted from 50 pulses/sec to 5,000 pulses/sec. For the high speed range, the BASE speed can be adjusted from 200 pulses/sec to 2,000 pulses/sec and the MAX speed can be adjusted from 200 pulses/sec to 20,000 pulses/sec. *Note: it is possible to have a MAX speed that is lower than the BASE speed. The BASE speed potentiometer is onboard; the MAX speed potentiometer is external (mounted on bracket).*

RAMPING

There are separate adjustments for acceleration and deceleration. The ramp times are adjustable from 50 milliseconds to 1.0 seconds. This is the time it takes to ramp from the lowest BASE speed to the highest MAX speed. In terms of acceleration units, the accel/decel rates are adjustable from 5,000 to 100,000 steps/sec² on the low speed range and 20,000 to 400,000 steps/sec² on the high speed range.

INPUTS (See Operating Modes)

STOP/RUN - When this input is open or Logic "1", the PG is stopped and will not output any pulses. When this input is pulled low to a logic "0", the PG will output pulses at the BASE speed rate if the BASE/MAX input is left open, or logic "1". If both the STOP/RUN and the BASE/MAX inputs are at a logic "0", the PG will ramp up and output pulses at the MAX speed rate. This input is only used in the "two-input" operation.

BASE/MAX - This input has two functions. In the Two-input operation, this input selects either BASE speed (Logic "1") or MAX speed (Logic "0"). When this input changes, the PG will ramp from one speed to the other.

In the Single-input operation, this input is used to start and stop the PG (Logic "1"=stop, Logic "0"=run). Upon starting, the PG will start running at BASE speed but

immediately ramp up to the MAX speed and keep running at the Max speed while this input is logic "0". When this input goes back to logic "1", the PG will either stop immediately, or it will ramp down and stop when it reaches BASE speed (depending on the JP2 setting). With Single-input operation, the PG only uses BASE speed as a starting speed; it cannot run at BASE speed for a long duration of time.

Note: the STOP/RUN input is NOT used with Single-input operation.

VCO IN - A voltage (0 to 4.9Vdc) can be fed into this input instead of using the MAX speed remote POT. The AA2876 will produce a frequency that is proportional to the voltage on this input. To use this input, the BASE/MAX input must be pulled to a Logic "0" and the MAX Speed POT disconnected. Please Note: the PG will start at BASE speed (set by the BASE speed POT) and ramp to the frequency determined by the voltage fed into the VCO Input. In most cases, it is best to set the BASE speed POT to the lowest setting when using the VCO Input. See Figure 6.

LIMITING THE MAX SPEED

In some applications, it may be necessary to limit the MAX speed so that the operator does not run the "machine" or system too fast. The "MAX Speed Limit" potentiometer can be adjusted to limit the top speed. This only affects the MAX speed; the BASE speed is unaffected.

OPERATING MODES

1. TWO INPUT OPERATION -

See Ramp Profile 1

- STOP/RUN is pulled low; Start at BASE speed and run for a while at BASE speed
- BASE/MAX is pulled low; Ramp up to MAX speed
- Both inputs are still low; MAX speed is reached (keep running at MAX speed)
- BASE/MAX input is let go, or pulled high and STOP/RUN is still low; Ramp down to BASE speed
- STOP/RUN is still low; BASE speed is reached
- STOP/RUN input is let go, or pulled high; STOP

2. SINGLE INPUT OPERATION W/ NO RAMPING DOWN*

See Ramp Profile 2

- BASE/MAX input is pulled low; Start at BASE speed and immediately ramp up to MAX speed
- BASE/MAX input is still low; MAX speed is reached
- BASE/MAX input is let go, or pulled high; STOP immediately

Note: In this mode, the PG ramps down internally even though pulses stop. Before starting again, the operator must allow sufficient time for the PG to ramp back down to BASE speed. The decel adjustment should be set for the fastest ramp down.

3. SINGLE INPUT OPERATION W/ RAMPING DOWN*

See Ramp Profile 3

- BASE/MAX input is pulled low; Start at BASE

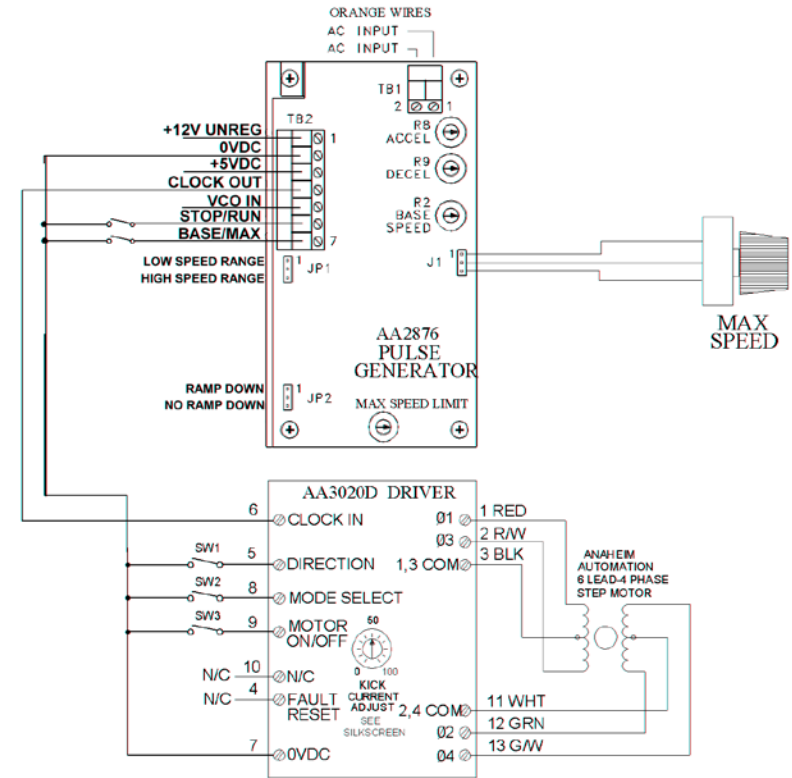

- speed and immediately ramp up to MAX speed
- B. MAX speed is reached
- C. BASE/MAX input is let go or pulled high; Ramp down
- D. Automatically stop when BASE speed is reached.

* NOTE: With single input operation, jumper JP2 is used to select RAMPING DOWN, or NO RAMPING DOWN.

Low Speed Range	1-2	----
High Speed Range	2-3	----
Ramp Up Only	----	2-3
Ramp Up and Down	----	1-2

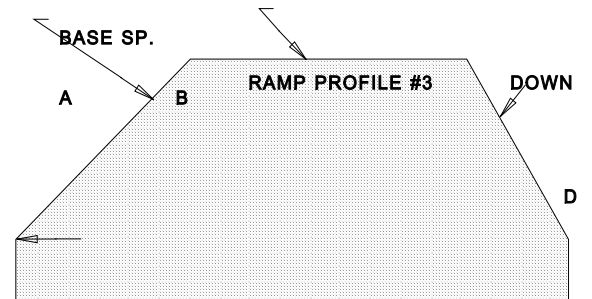
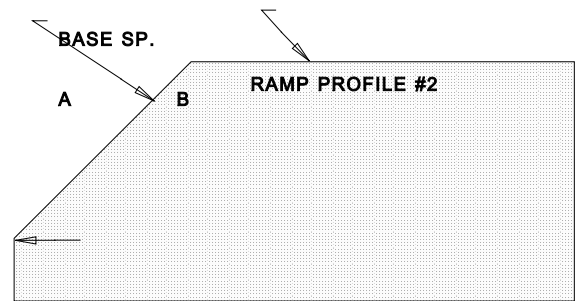
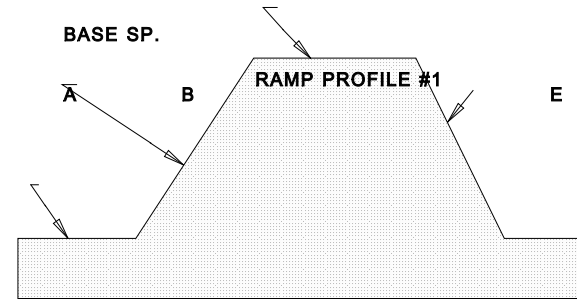

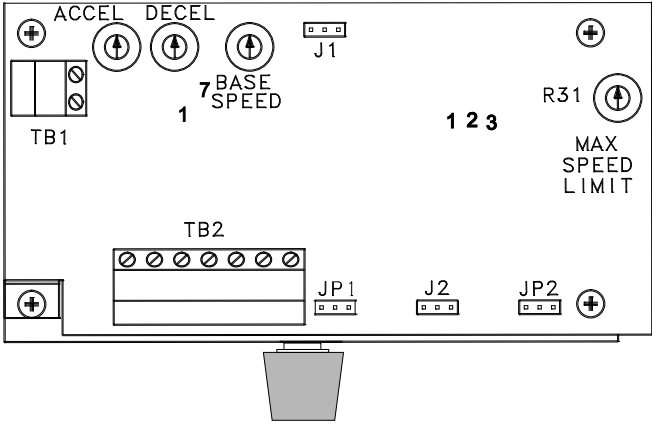

1	+12V UNREG INPUT	1	AC INPUT
2	0VDC	2	AC INPUT
3	+5VDC		
4	CLOCK OUT		
5	VCO IN		
6	STOP/RUN		
7	BASE/MAX		

VCO IN vs. Frequency Out
High Speed Range

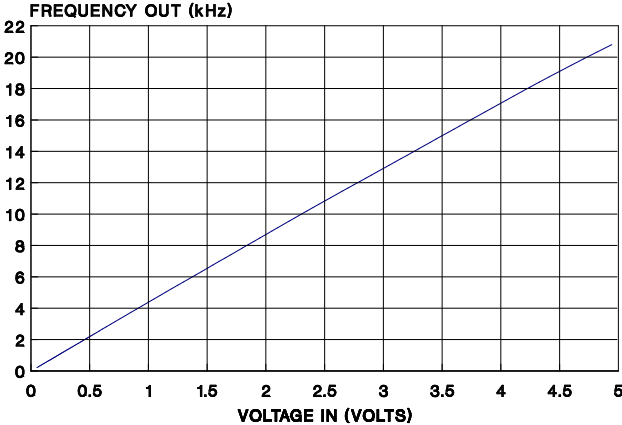

SPECIFICATIONS

DRIVER SPECIFICATIONS (BLD72/AA3020D)

CONTROL INPUTS (All) : (Terminals 5, 6, 8, 9) TTL-compatible

Logic "0" - 0 to 0.8 V

Logic "1" - 3.5 to 5.0 V

CLOCK INPUTS: (Terminal 6)

15 microseconds minimum pulse width required. The Clock Inputs are internally pulled up to +5Vdc through a 10KΩ resistor.

DIRECTION CONTROL: (Terminal 5)

Logic "1" (open) - CW motor direction

Logic "0" - CCW motor direction

EXCITATION MODE SELECT: (Terminal 8)

Logic "1" - Half-step

Logic "0" - Full-step

MOTOR ON/OFF: (Terminal 9)

Logic "1" (open) - motor current on

Logic "0" - motor current off

OUTPUT CURRENT RATING :(Terminals 1, 2, 3, 11, 12, & 13)

5 Amps per phase maximum operating or running current, and 3.5 Amps per phase maximum standstill current. Motor phase ratings of 0.5 Amp minimum are required to meet the minimum kick level.

OPERATING TEMPERATURE: 0 to 60 Degrees Celsius

The user must take into consideration where the unit is mounted, the duty cycle of operation and the ambient temperature. Care should be taken so that no point on the chassis exceeds 60 Degrees Celsius.

FUSE RATING: 2 Amp Slow Blow, 3AG

POWER REQUIREMENT: 50 - 60 Hertz

PULSE GENERATOR SPECIFICATIONS (AA2876)

BASE/MAX Input: pin 7, TB2

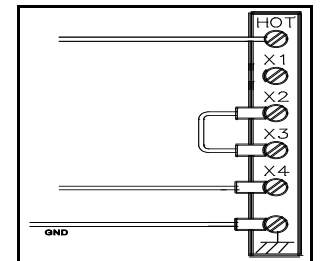
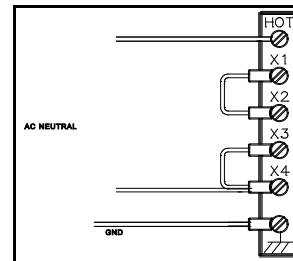

(10k ohm pullup)
Base speed - Logic "1" or open
Max speed (single input running) - Logic "0"

STOP/RUN Input: pin 6, TB2
(10k ohm pullup)
Stop - Logic "1" or open
Run - Logic "0"

VCO Input: pin 5, TB2
0 - 4.9Vdc
Input Impedance: 1 Meg ohm

PULSE OUTPUT: pin 4, TB2
Open collector, sink 100 mA

SPEED RANGES, approximate:
Low: BASE SPEED 50 - 500 pulses/sec
MAX SPEED 50 - 5,000 pulses/sec

High: BASE SPEED 200 - 2,000 pulses/sec
MAX SPEED 200 - 20,000 pulses/sec

RAMP TIMES: time to ramp from lowest BASE to highest MAX
50 milliseconds to 1.0 seconds

ACCELERATION/DECELERATION RATES:
5,000 - 100,000 pulses/s² for the Low speed range
20,000 - 400,000 pulses/s² for the High speed range

POWER SUPPLY OUTPUTS
+5VDC output: 1.5 Amps absolute maximum *
(see paragraph on +5VDC OUTPUT)
+12VDC unregulated output: 1.5 Amps maximum *
* No more than 1.5A total can be drawn from both of
these outputs simultaneously.

TROUBLESHOOTING DRIVER FAULTS

If a Fault occurs, reset the Fault by applying a Logic "0" to the Reset Fault Input (terminal 4) for at least 100ms (or by cycling power OFF for at least 15 seconds). After resetting, try to run the motor again. If the driver faults again, check the conditions listed below.

Is the LED blinking Slowly?

This indicates that the motor has a phase shorted or there is a short in the motor cable or wiring. Check the motor and the wiring for shorts. If the driver continues to sense "shorts" after the motor and wiring are determined to be good, then the output transistors should be checked (see below).

Is the LED blinking Quickly?

This indicates that there is an open connection in one of the motor wires. Check the motor and the wiring for opens. Another condition that may cause this type of fault is when a large motor is ramped down too quickly so that it loses its positioning.

Is the LED on Steadily?

This indicates that there is a ground fault - a voltage shorted to 0V. This detection is useful in detecting a short-to-case in a motor when the motor's case AND the driver's 0V are both connected to earth ground. Excessive noise on the 0V line may also cause the driver to sense this type of fault. This type of fault sensing may be disabled by placing jumper JP3 in position "1-2" (see figure 3A). NOTE: IF THE GROUND FAULT DETECTION IS DISABLED, DO NOT CONNECT THE DRIVER'S 0V TO EARTH GROUND!

Checking Output Transistors

1. Set the multimeter to Diode Test.
2. Place the RED meter lead on (between) the Sense Resistors (labeled Rs in Figure 4).
3. Touch the BLACK meter lead to each phase (terminals 1, 2, 12, and 13).
4. This should give readings between 0.450V and 0.550V.
5. If any readings are significantly less than 0.450V, then the unit has been damaged. To send the unit in for repair, contact the factory for an RMA#.

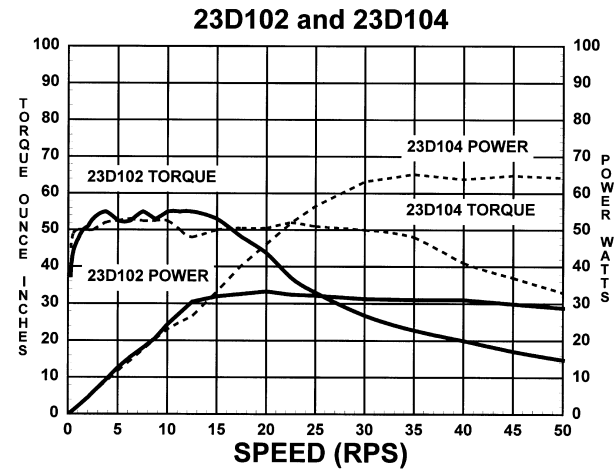

TORQUE/SPEED PERFORMANCE CURVES

34D207 and 34D307

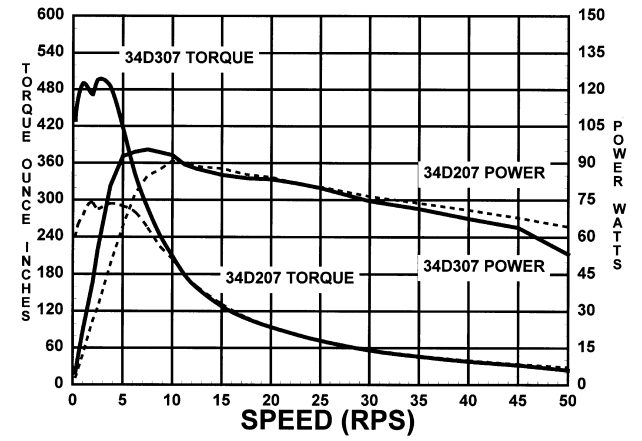

23D204 and 23D306

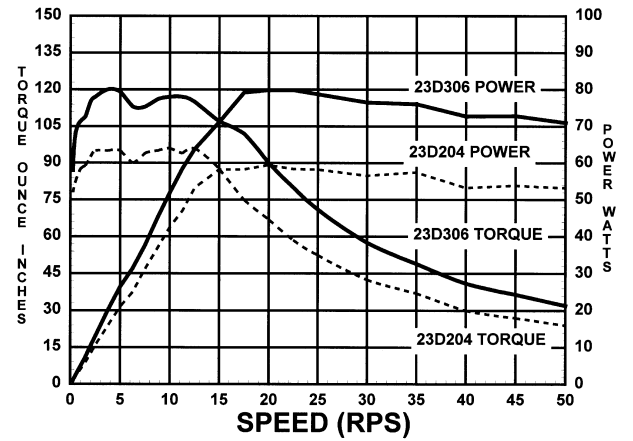

4985 E Landon Drive, Anaheim CA 92807
Phone (714) 992-6990 Fax (714) 992-047

