

# MBC10P31 Series Programmable Pulse Generator

## User's Guide



**ANAHEIM AUTOMATION**

4985 E. Landon Drive Anaheim, CA 92807  
e-mail: [info@anaheimautomation.com](mailto:info@anaheimautomation.com)

(714) 992-6990 fax: (714) 992-0471  
website: [www.anaheimautomation.com](http://www.anaheimautomation.com)

## MBC10P31 Features

- Output Current of 10.0A Peak
- 2000 Steps/Revolution
- On-Board Programmable Pulse Generator with 2 motion profiles
- Pulses From 1Hz to 50kHz
- Directional Soft and Hard Limit Switch Inputs
- Pulse Generator Clock Output
- Busy Output
- Motor On/Off Input and Automatic Current Reduction
- Short Circuit Protection

## General Description

The MBC10P31 is a low-cost single axis step motor driver integrated with a programmable pulse generator. The MBC10P31 microstep driver/pulse generator has an output current capability of 1.5A minimum to 10.0A maximum (peak rating). The MBC10P31 driver operates with a DC voltage of 20VDC to 80VDC. The MBC10P31's internal controller can store two different programmable motion profiles. The MBC10P31 also has directional soft and hard limit switch inputs, a busy output and a clock output that can be used for daisy chaining drivers together. The MBC10P31 driver features direction control and motor current On/Off capabilities. The "Reduce Current Enabled" feature automatically reduces motor current to 50% of the set value. The driver has built in features to indicate power on (green LED), running (yellow LED) and error conditions (red LED). The MBC10P31 has a fixed step resolution of 2000 steps/revolution for a 1.8° stepper motor. The bipolar drive configuration handles 4, 6, and 8 lead step motors and is also equipped with over current protection. The MBC10P31 communicates via USB communication. The easy to use Windows software, SMPG-SMSI Software, is used to directly set up the two different motion profiles.

## Motion Profiles and Running the Indexer

The programmable pulse generator has the ability to store two different motion profiles. The profiles include a base speed (starting speed), a maximum speeds (running speed) and an acceleration/deceleration. The base speed has a range of 1-5000Hz, the maximum speed has a range of 1 Hz-50kHz and the acceleration/deceleration has a range of 100 to 9,999,999 steps/sec<sup>2</sup>

There are "two ways" to get the unit to index: Examples are shown on the next page.

1. The first way is to directly control it from the computer with the software provided. Once the motion profiles have been set, the unit is ready to run. From the software, the user can select which profile to run and then click the begin motion button. If a soft limit command is sent or a soft limit input is activated, then the unit will immediately ramp down to base speed and stop. To stop motion immediately a hard limit command needs to be sent or a hard limit input must be activated.
2. The second way to make the unit run is to activate the run input. When the run input is activated, it looks at the max1\max2 input and selects from memory the speed profile that was selected. To stop motion, release the run input. When this input is release, the deceleration option will then either ramp down to base speed and stop or just hard stop. If a soft+ or soft limit switch is activated when the Run input is active, the pulse generator will ramp down to base speed and keep running. If a hard+ or hard- limit switch is activated when the run input is active, the motor will stop immediately.

## Operation with Ramp Down Option

- A. Run is activated; Starts at base speed and immediately ramps up to max speed.
- B. Run is still active; Max speed is reached (keeps running at max speed).
- C. Run is inactivated; Motor ramps down.
- D. Pulses automatically stop when base speed is reached.

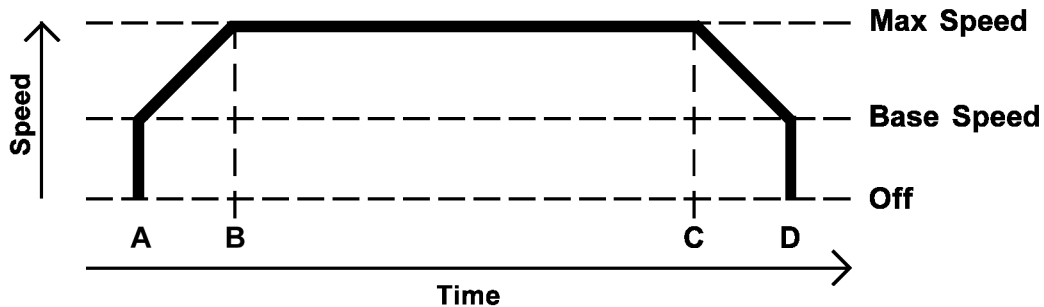

## Operation without Ramp Down Option

- A. Run is activated; Starts at base speed and immediately ramps up to max speed.
- B. Run is still active; Max speed is reached (keeps running at max speed).
- C. Run is inactivated; Motor stops immediately.

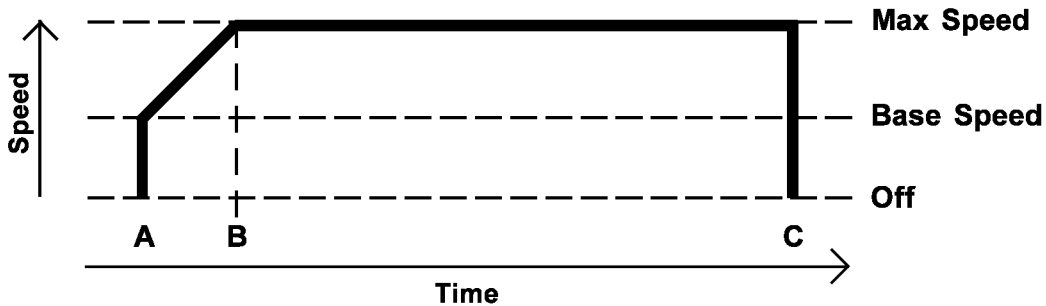

## Operation with Soft and Hard Limits

- A. Run is activated; Starts at base speed and immediately ramps up to max speed.
- B. Run is still active; Max speed is reached (keeps running at max speed).
- C. Run is still active; Soft limit is hit; Motor ramps down to base speed and keeps running.
- D. Run is still active; Base speed is reached (keeps running at base speed).
- E. Run is inactivated or Hard Limit is hit; Motor stops immediately.

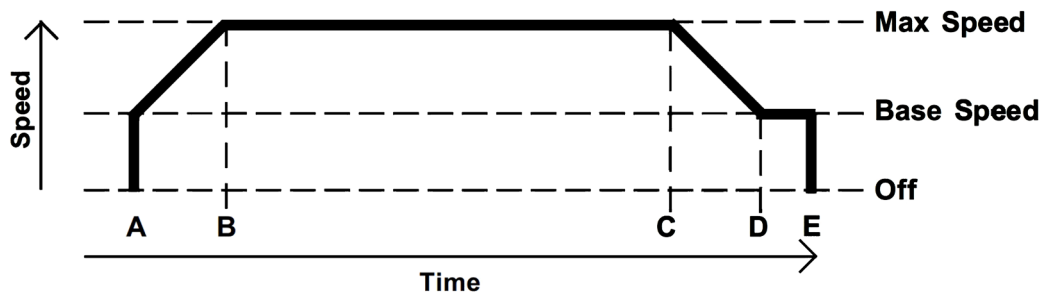

## LEDs

When powered and operated properly, the status LED will be green. When an error occurs, the LED will change to RED and an error code will be generated in the error code register. To read and clear the error with the software, click on the “Verify Parameters” button. To read and clear the error while in “Direct Mode” use the “!” command. Once the error has been read and cleared, the LED will return to green and the error code register will be cleared. Refer to the table page 20 for a list of the error codes. When the pulse generator is running the yellow LED will be on. Refer to the dimension drawing for location of the LEDs. For more detail on “Direct Mode” Refer to the Direct Talk Mode Section of User’s Guide.

## Baud Rates

A term used frequently in serial data communications. A “baud” is defined as the reciprocal of the shortest pulse duration in a data word signal, including start, stop, and parity bits. This is often taken to mean the same as “bits per second”, a term that expresses only the number of “data” bits per second. Very often, the parity bit is included as an information or data bit. The MBC10P31 only accepts a baud rate of 115.2k.

## Inputs and Outputs

**Inputs:** All inputs are pulled up to 5VDC. A logic “0” activates inputs that are pulled up. An unconnected input will always remain inactive.

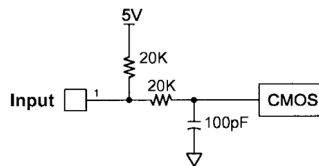

**Direction:** When this input is not active, the motor will be moving in the clockwise or “+” direction. When this input is active, the motor will move in the counterclockwise or “-” direction. This input is not read when a software index command is given. To change direction while using the software, change the direction option there. When two motors are used, the second motor will move in the opposite direction by default.

**On/Off:** When this input is not active, the motor will be enabled or energized. When this input is active, the motor will be disabled or de-energized.

**Run:** When this input is not active the pulse generator is stopped and will not output any pulses. When this input is active the pulse generator will output pulses starting at the base speed rate and will ramp up and output pulses at the max speed rate. When this input is released, the pulse generator will ramp down to base speed and stop or hard stop depending on the deceleration option.

**Max1/Max2:** This input is used to select which profile runs when the run input is activated. To use profile 1, then this input needs to be inactive (open). To use profile 2, then this input needs to be active.

**Soft Limits:** These two inputs are controlled by the direction of the pulse generator. When the pulse generator is running in the positive direction only soft+ will work. When the pulse generator is running in the negative direction then only soft- will work. When pulled low the motor will ramp down to base speed and continue running until the run input is released or a hard limit is reached.

**Hard Limits:** These inputs are controlled by the direction of the pulse generator. When the pulse generator is running in the positive direction only hard+ will work. When the pulse generator is running in the negative direction then only hard- will work. When pulled low the pulse generator will stop all pulses to the motor. To reverse off of a Hard Limit, change directions, and activate the run input again to move in the opposite direction.

**Busy Output:** This is an open drain output that is capable of sinking 75mA. It is current sinking when the indexer is running and open when the indexer is not running.

**Clock Output:** This is an open drain output that is capable of sinking 75mA. This output will pulse at the same frequency as the internal clock to the motor driver. It is pulled low during the active pulse of the pulse generator. When the pulse generator is not running this output is open.

## Connector Descriptions

Connector P2:	
Pin #	Description
1	Power Supply Ground (0VDC)
2	Power Supply Input (20VDC - 80VDC)
3	Motor Phase 1 (A)
4	Motor Phase 3 (/A)
5	Motor Phase 2 (B)
6	Motor Phase 4 (/B)
7	Run
8	Max 1/Max 2
9	Motor On/Off
10	Direction In
11	Busy Output
12	Clock Output
13	Soft Limit +
14	Soft Limit -
15	Hard Limit +
16	Hard Limit -

## Ordering Information

Part Number	Description
MBC10P31	10.0A Microstep Driver with integrated programmable Pulse Generator
PSA80V4A-1	Power supply for MBC10P31 (80V@4.0A)
AAUSB-6	6 foot USB communication cable, A-Male to B-Male

## Specifications

Voltage Requirements:	20 - 80 VDC	
Run Input (Pin 6):	Start	Low (0VDC)
Direction Input (Pin 10):	CW	High (Open)
	CWW	Low (0VDC)
On/Off Input (Pin 9):	On	High (Open)
	Off	Low (0VDC)
Busy Output (Pin 11):	Open Drain type Output, 75mA Sink, 40VDC Stand Off	
Clock Output (Pin 12):	Open Drain type Output, 75mA Sink, 40VDC Stand Off	
Clock Out Frequency (Pin 12):	Min	1 Hz
	Max	50kHz
Output Current: $T_A=25^\circ\text{C}$	Min	1.5A peak
	Max	10.3A peak
Driver Chopping Frequency:	25kHz - 30kHz	
Operating Temperature:	0° - 70° C	
LEDs	Green	Power On
	Red	Programming Error
	Yellow	Pulse Generator is busy
Com Port Settings:	115200,N,8,1	

## Dimensions

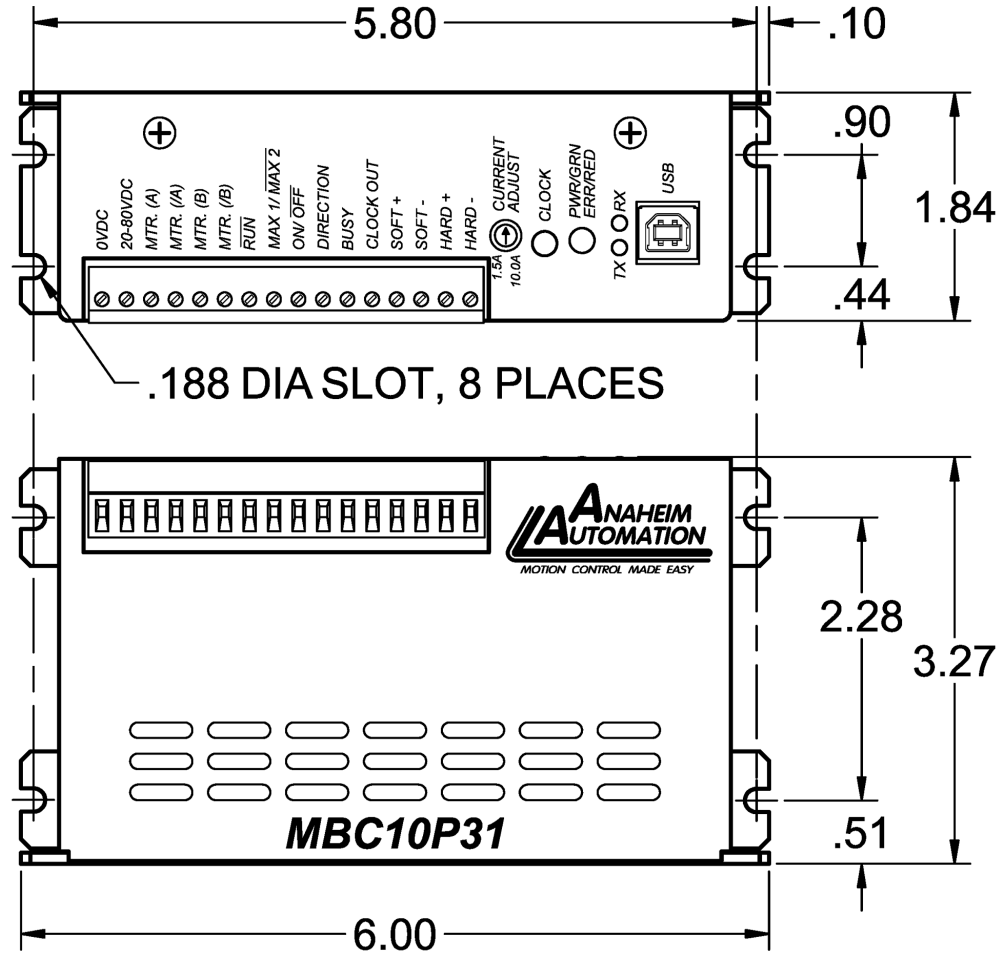

All units are in inches

## Wiring Diagrams

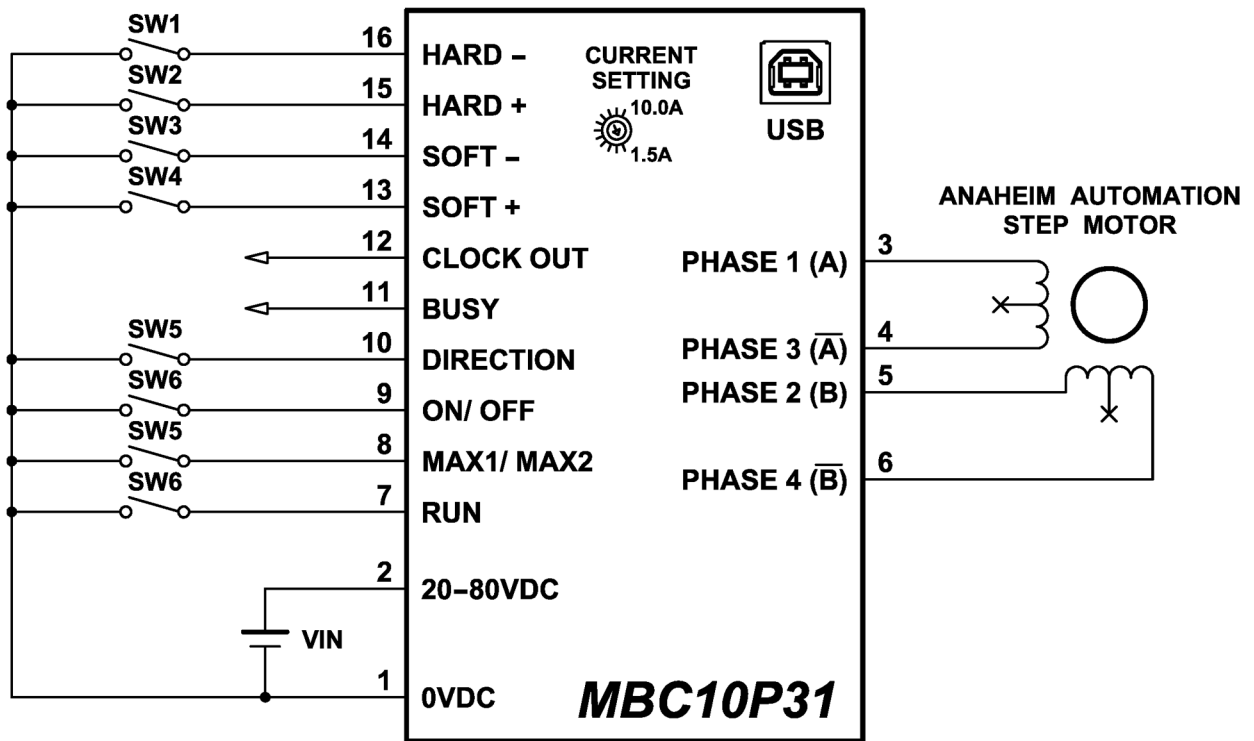

## Setting the Output Current

The output current on the MBC10P31 is set by the on-board potentiometer. This current adjust potentiometer determines the per phase peak output current of the driver. This relationship between the output current and the potentiometer setting is as follows:

### Potentiometer Settings

Peak Current	Potentiometer Setting
1.5A	0%
2.4A	10%
3.0A	20%
4.0A	30%
5.2A	40%
6.4A	50%
7.7A	60%
8.7A	70%
9.8A	80%
10.0A	90%
10.3A	100%

### Reducing Output Current

Reducing the output current is accomplished automatically depending on the current reduction setting in the SMPG-SMSI software. The amount of current per phase in the reduction mode is approximately 50% of the set current. When the current reduction circuit is activated, the current reduction resistor is paralleled with the current adjustment potentiometer. This lowers the total resistance value, and thus lowers the per phase output current. This is done when the pulse generator is not running.



## Determine Output Current

The output current used for motor when microstepping is determined differently from that of a full/half step unipolar driver. In the MBC10P31, a sine/cosine output function is used in rotating the motor. The output current for a given motor is determined by the motors current rating and the wiring configuration of the motor. There is a current adjustment potentiometer used to set the output current of the MBC10P31. This sets the peak output current of the sine/cosine waves. The specified motor current (which is the unipolar value) is multiplied by a factor of 1.0, 1.4, or 2.0 depending on the motor configuration (series, half-coil, or parallel).

## Step Motor Configurations

Step motors can be configured as 4, 6, or 8 leads. Each configuration requires different currents. Refer to the lead configurations and the procedures to determine their output current.

**WARNING!** Step motors will run hot even when configured correctly. Damage may occur to the motor if a higher than specified current is used. Most specified motor currents are maximum values. Care should be taken to not exceed these ratings.

### 6 Lead Motors

When configuring a 6 lead motor in a **half-coil configuration** (connected from one end of the coil to the center tap), multiply the specified per phase (or unipolar) current rating by 1.4 to determine the current setting potentiometer value. This configuration will provide more torque at higher speeds when compared to the series configuration.

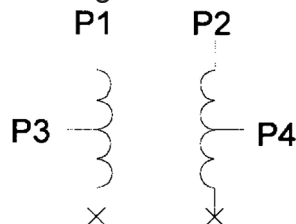

When configuring the motor in a **series configuration** (connected from end to end with the center tap floating) use the specified per phase (or unipolar) current rating to determine the current setting potentiometer value.

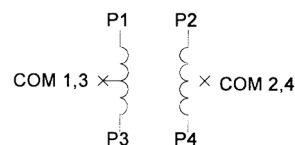

### 4 Lead Motors

Multiply the specified **series** motor current by 1.4 to determine the current adjustment potentiometer value. 4 lead motors are usually rated with their appropriate series current, as opposed to the *Phase Current*, which is the rating for 6 and 8 lead motors.

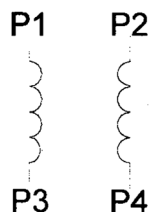

## 8 Lead Motors

**Series Connection:** When configuring the motor windings in series, use the per phase (or unipolar) current rating to determine the current setting potentiometer value.

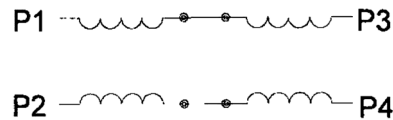

**Parallel Connection:** When configuring the motor windings in parallel, multiply the per phase (or unipolar) current rating by 2.0 to determine the current setting potentiometer value.

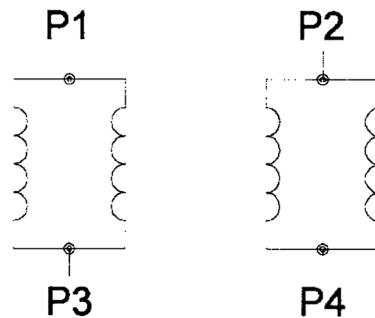

**Note:** After the current has been determined, according to the motor connections above, use the potentiometer setting table to choose the proper setting for the current setting potentiometer.

## Connecting the Step Motor

The MB10P31 is designed to accept one motor. For wiring of the motor refer to the pages containing the connector descriptions and hookup diagrams. The motor is wired into pins 3, 4, 5 and 6 of the terminal block.

**Note:** The physical direction of the motor with respect to the direction input will depend on the connection of the motor windings. To reverse the direction of the motor with respect to the direction input, switch the wires on phase 1 and phase 3. With the operation of 2 motors, they will run in the opposite direction when wired the same.

**WARNING:** Do not connect or disconnect motor wires while power is applied!

## Circuit Protection

This driver is equipped with over current protection.

**Note:** When drive experiences a fault condition, it will cease to function. Power down, inspect wiring, motors, etc. and allow for a 30 second pause to resume functioning. If driver is too hot, additional ventilation and airflow should be added to prevent temperature to exceed recommended temperature limit.

## Functions

**Hard Limit Switches:** When a hard limit switch is encountered, the pulses will stop. Hard limits are intended as an emergency stop for your system.

**Soft Limit Switches:** These switches cause the pulse generator to ramp down to the base speed and continue to run as the run input is still activated, unless encountering a hard limit switch.

**Run Input:** This input is used to begin the specified motion profile.

**Max1/Max2:** This input is used to select which profile runs when the run input is activated. To use profile 1, then this input needs to be inactive (open). To use profile 2, then this input needs to be active.

**Motion Profiles:** The indexer will accept two different speed or motion profiles. Each profile has its own programmable Accel/Decel, Base speed and Max speed. These values are stored in EEPROM for standalone use and must be programmed before the pulse generator is ran.

**Acceleration/Deceleration:** The acceleration and deceleration are by default the same value. This function controls the time that the motor will take to move from base speed to max speed. The higher the value, the faster the motor will accelerate. The same principle applies for the deceleration which is controlling the time it takes to go from maximum speed to base speed. The higher the value, the faster the pulses will decelerate. The different accel/decel profiles are stored in EEPROM for standalone use. (Range: 100 to 9,999,999)

**Base Speed:** The base speed is the speed at which motion starts and stops. It is entered directly as the number of steps per second. This speed must always be less than the max speed. The different base profiles are stored in EEPROM for standalone use. (Range:1 to 5000)

**Max Speed:** The max speed is the top speed the user wants the pulses to run at. This speed must always be equal or greater than the base speed. It is entered directly as the number of steps/second. The different max profiles are stored in EEPROM for standalone use. (Range:1 to 50,000)

**Direction Input:** If this input is open then the unit will be running in the clockwise direction. If this input is active then the unit will be running in the counterclockwise direction. This pin can be overridden by the programmable software direction. It will activate the direction output when the pin is changed. This means, that if you start the profile from the software, the unit will look at the software direction. If you start the indexer from the inputs, then the unit will look at the direction input.

**Busy Input:** This output will be pulled low when the pulse generator is operating. It is an open drain output so when the pulse generator is not running the pin is open.

**Clock Output:** This output will pulse at the same frequency as the internal clock to the motor driver. It is an open drain output and pulled low during the active pulse of the pulse generator. When the pulse generator is not running this output is open.

## SMPG-SMSI Software

The SMPG-SMSI software is a handy utility that supports Anaheim Automation's programmable pulse generators and simple indexers. Connecting your PC to the MBC10P31, via a USB cable, the software can easily perform the following tasks:

- Exercise and monitor the MBC10P31
- Directly communicate with the MBC10P31
- Program the profile values for the MBC10P31

## Installation

### Software

- The SMPG-SMSI software is supplied on a CD, containing the setup program and the software.
- SMPG-SMSI software is compatible with all versions of Windows including Windows 2000, Windows XP, Vista, and Windows 7.

### Windows 95/98/NT/ME/2000/XP Installation

#### Option 1

1. Insert the CD into the drive
2. From the Program Manager select **Start** | **R**un
3. Enter **D:\setup** and click **OK** - use the appropriate drive letter (i.e. **D** or **E**)

#### Option 2

1. Open Windows Explorer
2. Open CD Drive Folder (D: or E:)
3. Double Click the setup Icon

## Getting Started

1. Double click on the SMPG-SMSI icon to run the software.
2. Apply power to the MBC10P31 unit.
3. Set the appropriate communication setting by selecting Setup | Communication Setting from the menu bar.
4. Establish communications with the MBC10P31 by clicking on the Connect Icon, or select Setup | Connect. If the unit is connected properly, the program will notify you when communication has been established and the correct programming tab will be enabled to let you work with the unit.

After the 1st initial setup of the comport and axis settings, the MBC10P31 should connect to the software when the software is launched.

### Changing the COM Port Number of the USB Port

1. From **DeviceManager**, select "**View devices by type**", then "**Port (COM & LPT)**". Select the USB serial port and click **Properties**. Select the "**Port Settings**" tab, then click **Advanced**.
2. Choose the required COM port number from the list and click OK.

## “The Unit is Connected” / “The Unit is Not Connected”

On the right of the Toolbar, the user will find the communication status of the pulse generator. If communications is not established, please refer to the troubleshooting section.



## File Menu

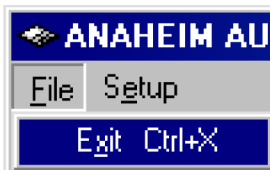

## Setup Menu

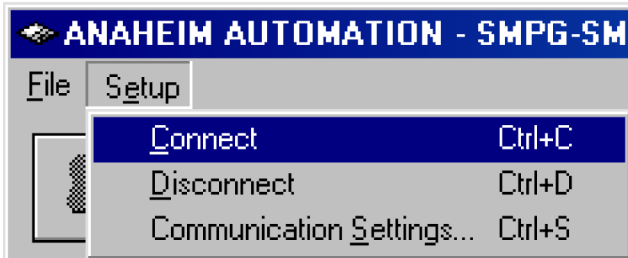

Exit	Exit the SMPG10WIN Software
Connect	Establish communications with the controller.
Disconnect	Discontinue communications and release the comport for use by other devices.
Communication Settings...	COM port Selection (Ports 1, 2, 3, 4, 5, 6, 7, 8, 9 or 10)

## Toolbar



Exit	Exit the SMPG-SMSI Software
Connect	Establish communications with the controller.

# Program Window

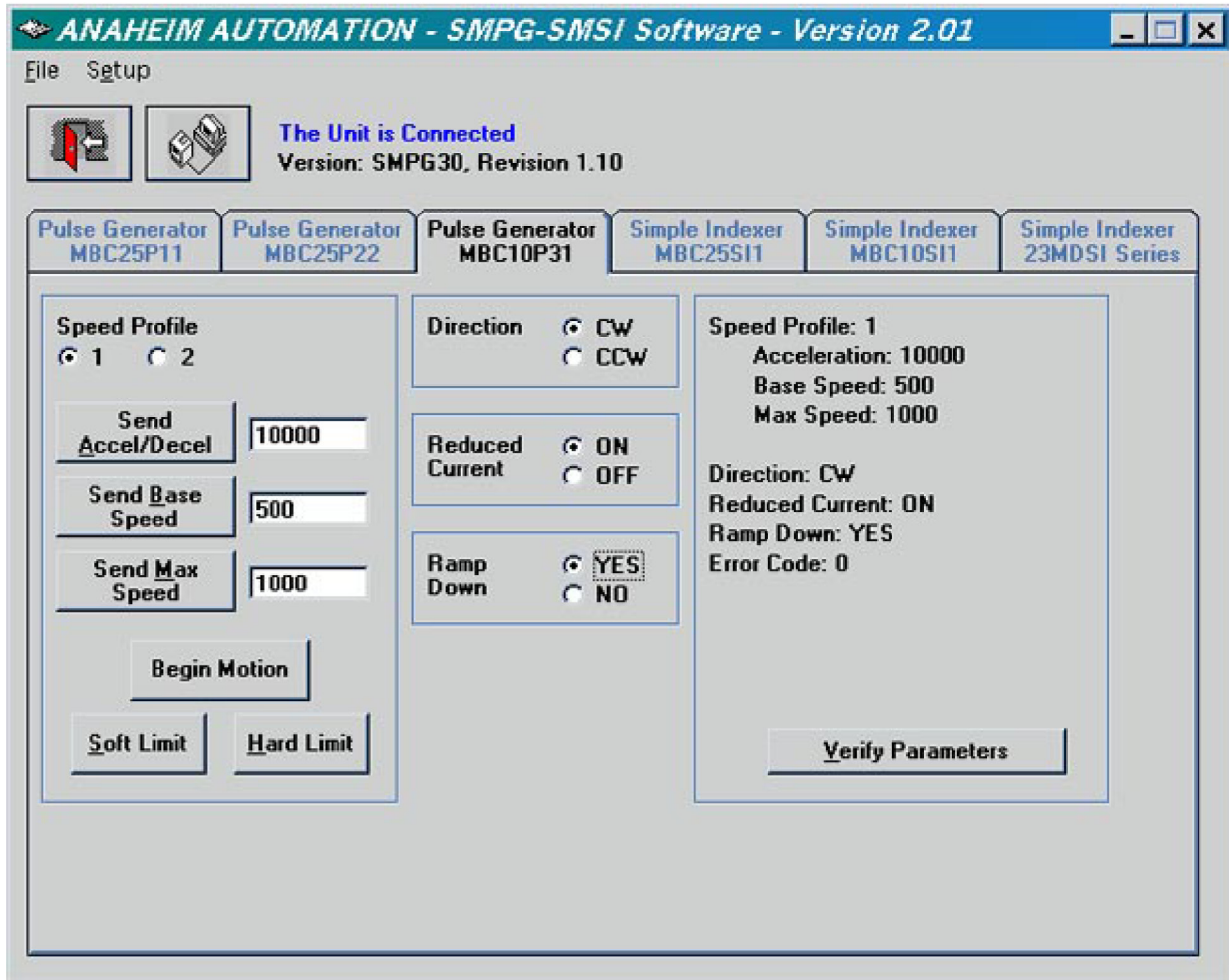

Motion Profile	Select motion profiles 1 or 2.
Send Accel/Decel	Send the acceleration & deceleration parameter to the indexer. (steps/sec <sup>2</sup> )
Send Base Speed	Send the base speed parameter to the indexer. (steps/sec)
Send Max Speed	Send the maximum speed parameter to the indexer. (steps/sec)
Begin Motion	Motor will ramp up to maximum speed and keep moving until a limit switch is triggered or the index is complete.
Soft Limit	Motor will ramp down to base speed stop.
Hard Limit	Stop any motor motion.
Direction	Set direction to clockwise or counter-clockwise.
Reduced Current	Set reduced current on or off.
Ramp Down	Set ramp down option to yes or no.
Verify Parameters	Updates and displays controllers parameters and resets the error codes.

## Direct Talk Mode

Direct mode is used to directly control the motion for real time movements through serial communication. The pulse generator has 13 command which are easy to remember for direct movement of a step motor.

## COM Port Settings

**Baud Rate:** 115200  
**Parity:** None  
**Data Bits:** 8  
**Stop Bits:** 1  
**Flow Control:** Xon/Xoff

## Unit Selection

In order to select a unit the @ command followed by 0 (address of the unit) must be sent.  
NOTE: There should be no spaces between the @ and the 0.

## How to select the unit:

@0 (Unit is selected)

## How to get a response from the unit:

@0\$ (Carriage Return)

After the \$ command, the pulse generator will return a SMSI40 + the current version number  
Note: In direct talk mode each command is followed by a carriage return.

The unit communicates in half duplex mode, therefore proper setup of hyper terminal is necessary to view characters, if characters are to be echoed back to the screen.

## Instructions

All instructions require that no spaces be sent between the command and the parameter followed by a carriage return. The commands are also case sensitive and are all sent as capitals.

## Command Summary:

**A** - Acceleration/Deceleration  
**B** - Base Speed  
**C** - Current Reduction  
**D** - Ramp Down  
**G** - Go (Run)  
**H** - Hard Limit  
**M** - Max Speed

**S** - Soft Limit  
**V** - Verify  
**+** - Clockwise Direction  
**-** - Counterclockwise Direction  
**\$** - Version Number Register  
**!** - Error Codes Register

## **\$ - Versions Number Register**

Format:        \$

Description:   This command request the pulse generator to return the version number.

## **! - Error Codes Register**

Format:        !

Description:   This command requests the pulse generator to get the current error code and print it to screen.

## **+/- - Direction**

Format:        + or -

Description:   This command sets the direction output. A “+” sets the output to clockwise, and a “-” set the output to counterclockwise. This must be done when the indexer is not busy. This value is saved in the EEPROM for standalone use.

## **A - Acceleration/Deceleration**

Format:        A#[value] - where # is the motion profile number 1 or 2

Sample:        A1\_10000    Accel of profile 1 equals 10000

Description:   This command sets the acceleration profile which can be an integer value between 100 and 9,999,999. These values are saved in the EEPROM for standalone use.

Range:         100 - 9,999,999

## **B - Base Speed**

Format:        B#[value] - where # is the motion profile number 1 or 2

Sample:        B2\_500       Base Speed of profile 2 equals 500

Description:   This command sets the base (start) speed for motion. This value must be set before motion begins and be less then the maximum speed. The pulses will ramp down to this speed after a soft limit is triggered and run at this speed until a hard limit is triggered or the index has finished. These values are saved in the EEPROM for standalone use.

Range:         1 - 5000



## **C - Current Reduce Option**

Format: C# - where # is 0 or 1

Description: This command enables the driver to reduce current after pulses are done being sent. A 1 will enable current reduction, and a 0 will disable current reduction. This value is saved in the EEPROM for standalone use.

## **D - Ramp Down**

Format: D# - where # is 0 or 1

Description: This command enables the driver to ramp down or stop hard once the run input is released. A 1 will cause the motor to ramp down, and a 0 will cause the motor to stop hard. This value is saved in the EEPROM for standalone use.

## **G - Go Slew (Run)**

Format: G# - where # is the speed profile number 1 or 2

Description: This command will send clocks out to the pulse generator. There are only 2 commands that can stop the clocks. One is the H (stop motion). The other is the S (soft limit) command which will make the pulses go from max speed to base speed and then stop the motor. Motion can also be stopped by using the limit switch inputs. The ramp profile is specified by the B (base speed), M (max speed), and A (acceleration/deceleration) commands.

## **H - Hard Limit or Stop Motion**

Format: H

Description: This command will stop all motion. It can only be used when pulses are running.

## **M - Max Speed**

Format: M#\_[value] - where # is the motion profile number 1 or 2

Sample: M2\_10000 Max Speed of profile 2 equals 10000

Description: This command sets the maximum (running) speed for motion. This value must be set before motion begins and be equal or greater than the base speed. The motor will run at this speed until a soft limit or a hard limit is triggered. These values are saved in the EEPROM for standalone use.

Range: 1 - 50,000

## S - Stop Soft

Format: S

Description: This command will cause the pulse generator to ramp down to base speed and stop. It can only be used when pulses are running.

## V - Verify

Description: This command can be used with most commands to verify the register contents. This is a read only command. Valid Commands are: A, B, C, D, M, R, and +.

Format: V[command]

This format is good for C, D, R, and +.

- C - If a 1 is sent back then the driver is in reduced current mode. If a 0 is sent back then the driver is not in reduced current mode.
- D - If a 1 is sent back then the pulse generator will ramp down to stop when the Run/Stop input is released. If a 0 is sent back then the pulse generator will stop hard when the Run/Stop input is released.
- + - If a 1 is sent back then the direction is clockwise. If a 0 is sent back then the direction is counterclockwise.

Sample: V+ Verification of Direction is prompted.

Format: V[command]# - Where # is the speed profile number 1 thru 4

This format is good for A, B, and M.

- A# - Verify Acceleration/Deceleration for given speed profile.
- B# - Verify Base Speed for given speed profile.
- M# - Verify Max speed for given speed profile.

Sample: VB2 Verification of Base Speed in Profile 2 is prompted.

## Visual Basic Direct Mode Programming Examples

### Example 1: This Example is for Axis=0, and Profile=1

```
DimConst DefaultTimeout As Single = 0.5
frmMain.MSComm1.Output = "@0A1_100000" & Chr$(13) 'SetAcceleration
Pause DefaultTimeout
frmMain.MSComm1.Output = "@0B1_1000" & Chr$(13) 'Set Base Speed
Pause DefaultTimeout
frmMain.MSComm1.Output = "@0M1_4000" & Chr$(13) 'Set Maximum Speed
Pause DefaultTimeout
frmMain.MSComm1.Output = "@0+1_500" & Chr$(13) 'Set Direction CW
Pause DefaultTimeout
frmMain.MSComm1.Output = "@0D1_100" & Chr$(13) 'Set Ramp Down On
Pause DefaultTimeout
frmMain.MSComm1.Output = "@0G1" & Chr$(13) 'Start the Index
Pause DefaultTimeout
```

### Example 2: This Example receives the error code and Version Number from Axis3

```
DimConst DefaultTimeout As Single = 0.5
frmMain.MSComm1.Output = "@3!" & Chr$(13)
Pause ShortTimeOut
MsgBox RecieveAscii()
frmMain.MSComm1.Output = "@3$" & Chr$(13)
Pause ShortTimeOut
MsgBox RecieveAscii()
```

```
Function ReceiveAscii() As String
'wait for the incoming data to get to the buffer
Dim BeginTime as Single
Dim A As Integer
Dim B As Integer
BeginTime = Timer
While Main.MSComm1.InBufferCount = 0
DoEvents
If Timer - BeginTime > 0.1 Then GoTo ExitRoutine1
Wend
A = 0: B = Main.MSComm1.InBufferCount
While A <> B
A = Main.MSComm1.InBufferCount
Pause 0.02 ' Fixed time value
B = Main.MSComm1.InBufferCount
Wend

ReceiveAscii = Main.MSComm1.Input
Exit Function
```

## Troubleshooting

### Problem:

*Can not establish communications with the unit.*

### Possible Solutions:

1. Make sure the indexer has power. Is the Green LED on.
2. Check USB connections.
3. Check for loose cable connection either on the pulse generator or USB Port.
4. Was the software installed successfully?
5. Go to **Setup | Communication Settings** and verify COM Port settings.
6. Click on **Connect** icon to communicate with the unit.
7. If problems still exist, contact Anaheim Automation Tech Support.

### Problem:

*There is no power to the indexer.*

### Possible Solutions:

1. Is the Indexer connected to the appropriate power supply?
2. Check for any blown fuses in line with the unit.
3. If problems still exist, contact Anaheim Automation at 714-992-6990.

### Problem:

*The indexer has a fault condition.*

### Possible Solutions:

1. To Clear an error use either the SMPG-SMSI software or the direct mode command.
2. The SMPG-SMSI software can clear an error in the motion tab section by clicking on the Verify Parameters button.
3. The direct mode command "!" can clear an error by prompting indexer to serially send the error code back to the user.

Example: @0! (carriage return)

Description: Address the unit by typing @ followed by a 0 (address number) an ! (Error Codes Register) and a carriage return.

Note: The error code is returned in binary coded decimal format. If two errors were received their binary values would be added together.

## Error Codes

Error Code	Type	Description
1	Receive Overflow Error	The serial communications had a receiving error. This is an internal error caused by the computer.
2	Range Error	There was an invalid number of characters sent to the pulse generator. Check to see if the parameters are invalid for the command that was sent.
4	Command Error	A bad command was sent to the pulse generator. Please check to see that the command being sent is valid, or that the pulse generator is not running.
8	Transmitt Error	To many parameters sent back to the PC. This is an internal error cause by the EEPROM.
16	Motor Error	Motor speed profiles are set incorrectly. Please make sure that the base speed is less than the max speed and that the speeds are within their valid ranges.
32	Zero Parameters Error	There were no parameters sent to the pulse generator. A command was sent to the pulse generator that expected to see parameters after the command.

## ASCII Table for Direct Mode

ASCII Symbol	Hex Value	ASCII Symbol	Hex Value
Carriage Return	0D	C	43
0	30	D	44
1	31	G	47
2	32	H	48
3	33	M	4D
4	34	S	53
5	35	V	56
6	36	!	21
7	37	\$	24
8	38	+	2B
9	39	-	2D
A	41	_	5F
B	42		

## **COPYRIGHT**

Copyright 2007 by Anaheim Automation. All rights reserved. No part of this publication may be reproduced, transmitted, transcribed, stored in a retrieval system, or translated into any language, in any form or by any means, electronic, mechanical, magnetic, optical, chemical, manual, or otherwise, without the prior written permission of Anaheim Automation, 4985 E Landon Drive, Anaheim, CA 92807.

## **DISCLAIMER**

Though every effort has been made to supply complete and accurate information in this manual, the contents are subject to change without notice or obligation to inform the buyer. **In no event will Anaheim Automation be liable for direct, indirect, special, incidental, or consequential damages arising out of the use or inability to use the product or documentation.**

Anaheim Automation's general policy does not recommend the use of its' products in life support applications wherein a failure or malfunction of the product may directly threaten life or injury. Per Anaheim Automation's Terms and Conditions, the user of Anaheim Automation products in life support applications assumes all risks of such use and indemnifies Anaheim Automation against all damages.

## **LIMITED WARRANTY**

All Anaheim Automation products are warranted against defects in workmanship, materials and construction, when used under Normal Operating Conditions and when used in accordance with specifications. This warranty shall be in effect for a period of twelve months from the date of purchase or eighteen months from the date of manufacture, whichever comes first. **Warranty provisions may be voided if products are subjected to physical modifications, damage, abuse, or misuse.**

Anaheim Automation will repair or replace at its' option, any product which has been found to be defective and is within the warranty period, provided that the item is shipped freight prepaid, with previous authorization (RMA#) to Anaheim Automation's plant in Anaheim, California.

## **TECHNICAL SUPPORT**

If you should require technical support or if you have problems using any of the equipment covered by this manual, please read the manual completely to see if it will answer the questions you have. If you need assistance beyond what this manual can provide, contact your Local Distributor where you purchased the unit, or contact the factory direct.

**ANAHEIM AUTOMATION**