

MBC01081 Series Bipolar Microstep Driver

User's Guide

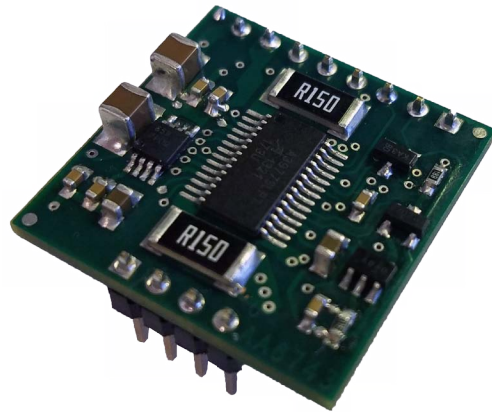

ANAHEIM AUTOMATION

4985 E. Landon Drive Anaheim, CA 92807
e-mail: info@anaheimautomation.com

(714) 992-6990 fax: (714) 992-0471
website: www.anaheimautomation.com

MBC01081 Driver Features

- 0.2A - 1.0 Amps/Phase Output Current
- PCB Board Mount
- Bipolar Microstepping Drive Operation
- Over Temperature and Short Circuit Shutdown
- Microstep Divisors of 8, 4, 2, or Full Step
- Compact Package: 0.95" x 0.95" x 0.45"
- 10-30VDC Power Requirement
- Accepts TTL Logic Inputs
- Ideal for Precise Positioning
- Efficient and Durable
- Long Life Expectancy

General Description

The MBC01081 is a 1.0 amps/phase bipolar microstep driver capable of running four, six and eight lead step motors. The MBC01081 has an output current range of 0.2 to 1.0 amps/phase and operates off 10VDC minimum to 30VDC maximum. The inputs are capable of running from either open collector or TTL level logic outputs from PLCs. The MBC01081 features resolutions from 200-1600 steps/revolution, providing smooth rotary operation, built in over temperature and short circuit shut down, and automatic reduction in current after clock pulses stop being received. The MBC01081 is a compact, low profile package meant to be used where space is limited but performance is expected. With two connector arrays arranged in a 2.54 mm pattern, it allows easy integration and connectivity to the OEM-side mother board.

Fault Protection

A cycle-by-cycle over current protection is provided when the motor current level exceeding the 1.5A peak current limit is produced. When the over current protection is activated, the controller shuts off the outputs to the motor.

Dimensions

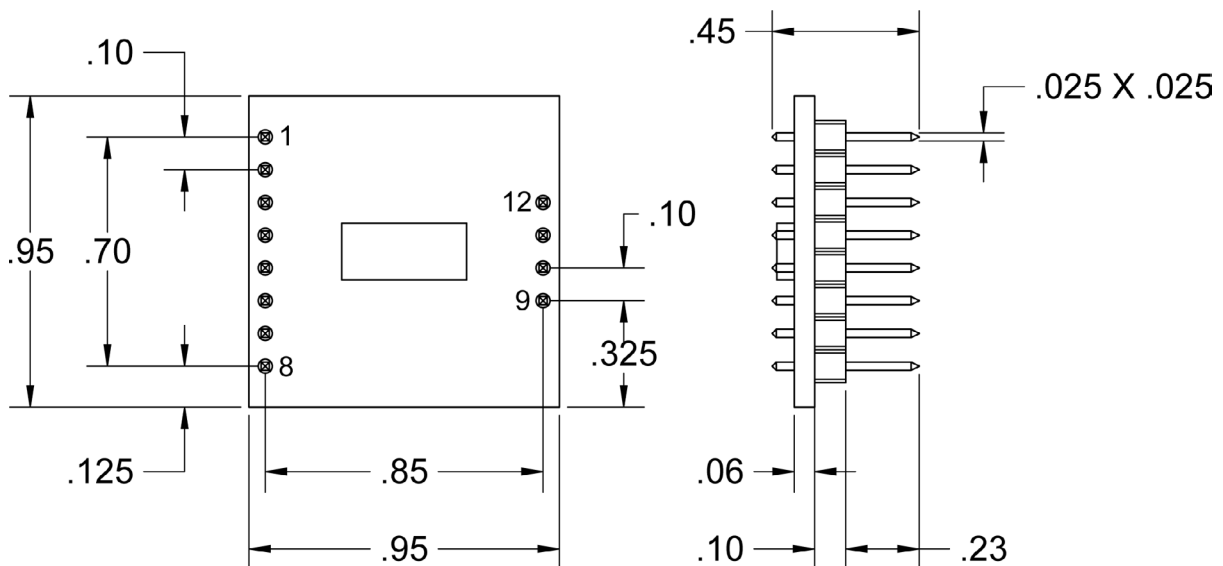

Hook-Up Diagram

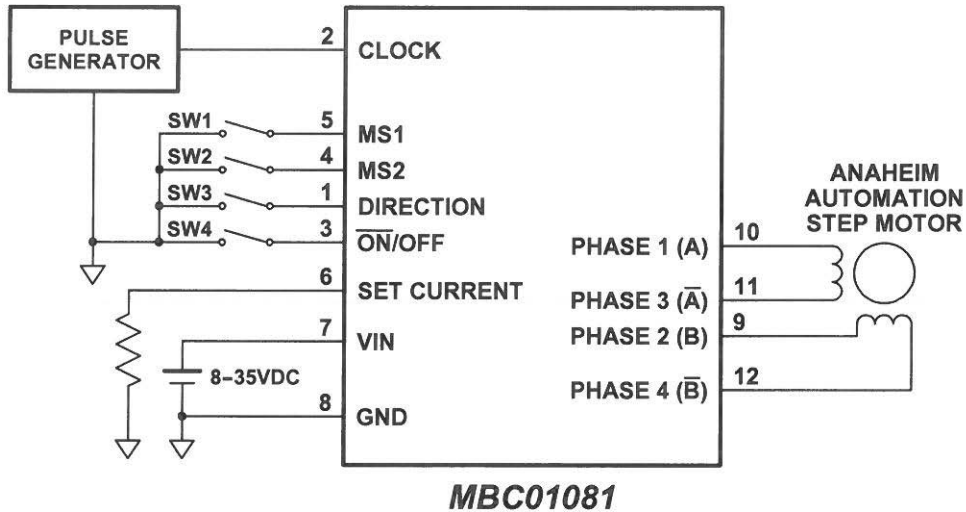

Input Pin Descriptions	
Pin #	Description
1	Direction
2	Clock
3	(On)/Off
4	MS2
5	MS1
6	Set Current
7	12VDC-24VDC
8	0VDC (Gnd)

Motor Pin Descriptions	
Pin #	Description
9	Phase B
10	Phase A
11	Phase A/
12	Phase B/

Control Inputs (Pins 1, 2, 3, 4, 5):

Microstep Resolution Truth Table		
MS1	MS2	Resolution
Active	Active	Full Step
Inactive (Open)	Active	Half Step
Active	Inactive (Open)	Quarter Step
Inactive (Open)	Inactive (Open)	Eighth Step

- Direction:** Logic "1" CW
Logic "0" CCW
- Clock:** Active - 1 Step
Inactive (open) - Reduce Current Mode
- On/Off:** Active - ON
Inactive (open) - OFF

Notes:
Open Inputs are inactive and internally pulled up to +5VDC.

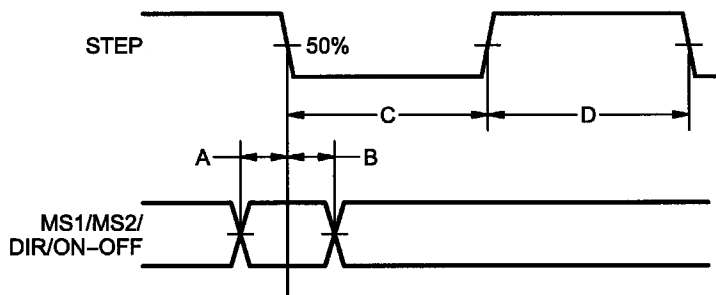

- A. Minimum Command Active Time Before Clock Pulse (Data Set-Up Time)...200nS
B. Minimum Command Active Time After Clock Pulse (Data Hold Time)
C. Minimum CLOCK Pulse Width.....1.0uS
D. Minimum CLOCK Inactive Time.....1.0uS
Maximum CLOCK Frequency.....500kHz

Setting the Output Current:

The output current on the MBC01081 is set by an external resistor connected between Set Current (pin 6) and Ground (pin8). This resistor determines the per phase peak output current of the driver. The relationship between the output current and the resistor value is shown below.

Warning! Step motors will run hot even when configure correctly. Damage may occur to the motor if a higher than specified current is used. Most specified motor currents are maximum values. Care should be taken to not exceed these ratings.

Reducing Output Current

Reducing the output current is accomplished automatically and occurs approximately 20mSec after the last clock input has been received and a logic "0" is on the clock pin. When the current reduction circuit is activated, the current reduction resistor is paralleled with the current sense resistor. This lowers the total resistance value, and thus lowers the per phase output current.

MBC01081 Current Set Resistor Values

Resistor Value	Peak Current	Reduce Current
200 ohms	0.2A	0.15A
700 ohms	0.4A	0.28A
1500 ohms	0.6A	0.37A
5000 ohms	0.8A	0.45A
Open	1.0A	0.5A

Connecting the Step Motor

Phase 1 and Phase 3 of the step motor are connected to pins 1 and 2 on connector P2. Phase 2 and Phase 4 of the step motor are connected to pins 3 and 4 on connector P2. Please refer to the figure for a TYPICAL APPLICATION HOOK-UP.

Note: The physical direction of the motor with respect to the direction input will depend on the connection of the motor windings. To reverse the direction of the motor with respect to the direction input, switch the wires on Phase 1 and Phase 3.

WARNING: DO NOT CONNECT OR DISCONNECT MOTOR WIRES WHILE POWER IS APPLIED!

Motor Selection

The MBC25081TB is a Bipolar Microstep Driver that is compatible with both Bipolar and Unipolar Motor Configurations, (i.e. 8 and 4 lead motors, and 6 lead center tapped motors).

Step motors with low current ratings and high inductance will perform better at low speeds, providing higher low end torque. Motors with high current ratings and low inductance will perform better at higher speeds, providing more high-end torque.

Since the MBC25081TB uses a constant current source drive technique, it is not necessary to use a motor that is rated at the same voltage as the supply voltage. What is important is that potentiometer is set to the appropriate current level based on the motor being used. Higher voltages will cause the current to flow faster through the motor coils. This in turn means higher step rates can be achieved. **Care should be taken not to exceed the maximum voltage of the driver.**

Step Motor Configurations

Step motors can be configured as 4, 6, or 8 leads. Each configuration requires different currents. Refer to the lead configurations and the procedures to determine their output current.

Determine Output Current

The output current for a motor used with a bipolar driver is determined differently from that of a unipolar driver. In the MBC01081, a sine/cosine output function is used in rotating the motor. The output current for a given motor is determined by the motor's current rating and the wiring configuration of the motor. There is a current adjustment resistor used to set the output current of the MBC01081. This sets the peak output current of the sine/cosine waves. The specified motor current (which is the unipolar value) is multiplied by a factor of 1.0, 1.4, or 2.0 depending on the motor configuration (series, half-coil, or parallel).

6 Lead Motors

Half-Coil Connection: When configuring a 6 lead motor in half-coil (connected from one end of the coil to the center tap), multiply the specified per Phase (or unipolar) current rating by 1.4 to determine the current setting resistor value. This configuration will provide more torque at higher speeds when compared to the series configuration.

Series: When configuring the motor in series (connected from end to end with the center tap floating) use the specified per Phase (or unipolar) current rating to determine the current setting resistor value.

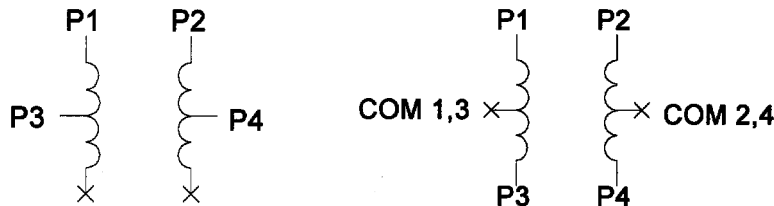

8 Lead Motors

Series Connection: When configuring the motor windings in series, use the per Phase (or unipolar) current rating to determine the current setting resistor value.

Parallel Connection: When configuring the motor windings in parallel, multiply the per Phase (or unipolar) current rating by 2.0 to determine the current setting resistor value.

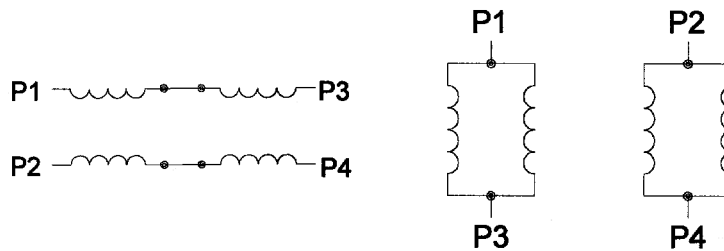

4 Lead Motors

Series Connection: Multiply the specified series motor current by 1.4 to determine the current adjustment resistor value. Four Lead Motors are usually rated with their appropriate series current, as opposed to the *Phase Current*, which is the rating for 6 and 8 lead motors.

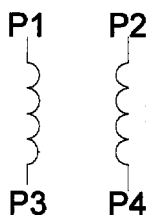

Torque Speed Curves

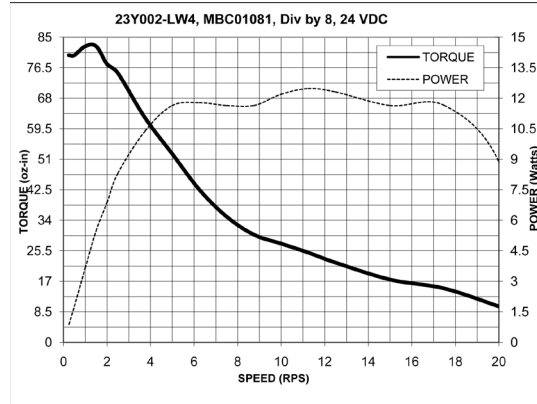
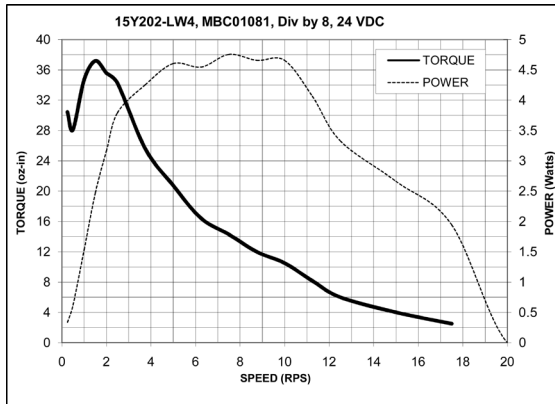

COPYRIGHT

Copyright 2017 by Anaheim Automation. All rights reserved. No part of this publication may be reproduced, transmitted, transcribed, stored in a retrieval system, or translated into any language, in any form or by any means, electronic, mechanical, magnetic, optical, chemical, manual, or otherwise, without the prior written permission of Anaheim Automation, 4985 E Landon Drive, Anaheim, CA 92807.

DISCLAIMER

Though every effort has been made to supply complete and accurate information in this manual, the contents are subject to change without notice or obligation to inform the buyer. **In no event will Anaheim Automation be liable for direct, indirect, special, incidental, or consequential damages arising out of the use or inability to use the product or documentation.**

Anaheim Automation's general policy does not recommend the use of its' products in life support applications wherein a failure or malfunction of the product may directly threaten life or injury. Per Anaheim Automation's Terms and Conditions, the user of Anaheim Automation products in life support applications assumes all risks of such use and indemnifies Anaheim Automation against all damages.

LIMITED WARRANTY

All Anaheim Automation products are warranted against defects in workmanship, materials and construction, when used under Normal Operating Conditions and when used in accordance with specifications. This warranty shall be in effect for a period of twelve months from the date of purchase or eighteen months from the date of manufacture, whichever comes first. **Warranty provisions may be voided if products are subjected to physical modifications, damage, abuse, or misuse.**

Anaheim Automation will repair or replace at its' option, any product which has been found to be defective and is within the warranty period, provided that the item is shipped freight prepaid, with previous authorization (RMA#) to Anaheim Automation's plant in Anaheim, California.

TECHNICAL SUPPORT

If you should require technical support or if you have problems using any of the equipment covered by this manual, please read the manual completely to see if it will answer the questions you have. If you need assistance beyond what this manual can provide, contact your Local Distributor where you purchased the unit, or contact the factory direct.

ANAHEIM AUTOMATION